







Kühlung	
Toleranz	h7
Beschichtung	BetaUni Iron



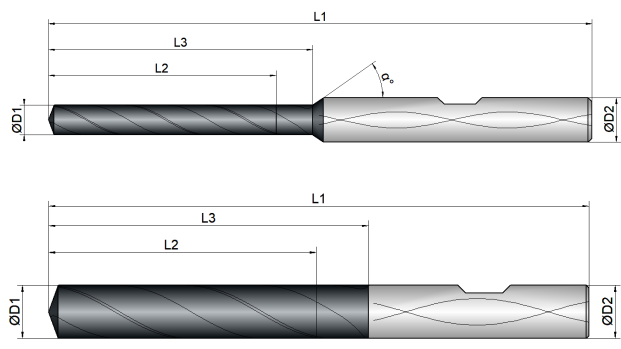
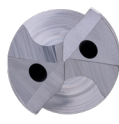

Strategie	UNI	HPC		
Anwendung				
Eigenschaften	HB	5xD	140°	

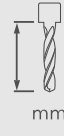





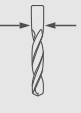

- Vielseitig einsetzbare Universalgeometrie
 - Doppelt geführter Spanraum für ideale Spanabfuhr
 - Polierte Oberflächen für minimalen Reibungswiderstand
-
- Speziell geschwungene Stirnschneide für höhere Vorschübe und eine sichere Zentrierung



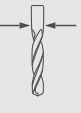

	D1	L2	L3	D2	L1
BCU1-D01-0224	 mm ∅	 mm	 mm	 mm ∅	 mm
2,5	2,5	19	22	4	57
2,6	2,6	19	22	4	57
2,7	2,7	19	22	4	57
2,8	2,8	19	22	4	57
2,9	2,9	19	22	4	57
3	3	24	28	6	66
3,1	3,1	24	28	6	66
1/8	3,175 (1/8")	24	28	6	66
3,2	3,2	24	28	6	66
3,25	3,25	24	28	6	66
3,3	3,3	24	28	6	66
3,4	3,4	24	28	6	66
3,5	3,5	24	28	6	66
3,6	3,6	24	28	6	66
3,7	3,7	24	28	6	66
3,75	3,75	24	28	6	66

BCU1-D01-0224	 D1 mm ∅	 L2 mm	 L3 mm	 D2 mm ∅	 L1 mm
3,8	3,8	31	36	6	74
3,9	3,9	31	36	6	74
5/32	3,96875 (5/32 ")	31	36	6	74
4	4	31	36	6	74
4,1	4,1	31	36	6	74
4,2	4,2	31	36	6	74
4,3	4,3	31	36	6	74
4,4	4,4	31	36	6	74
4,5	4,5	31	36	6	74
4,6	4,6	31	36	6	74
4,65	4,65	31	36	6	74
4,7	4,7	31	36	6	74
4,75	4,75	31	36	6	74
3/16	4,7625 (3/16 ")	38	44	6	82
4,8	4,8	38	44	6	82
4,9	4,9	38	44	6	82
5	5	38	44	6	82
5,1	5,1	38	44	6	82
5,2	5,2	38	44	6	82
5,3	5,3	38	44	6	82
5,4	5,4	38	44	6	82
5,5	5,5	38	44	6	82
5,55	5,55	38	44	6	82
7/32	5,5625 (7/32 ")	38	44	6	82
5,6	5,6	38	44	6	82
5,65	5,65	38	44	6	82
5,7	5,7	38	44	6	82
5,75	5,75	38	44	6	82
5,8	5,8	38	44	6	82

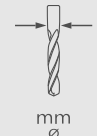
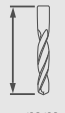
BCU1-D01-0224	 mm ∅	 mm	 mm	 mm ∅	 mm
5,9	5,9	38	44	6	82
6	6	38	44	6	82
6,1	6,1	45	53	8	91
6,2	6,2	45	53	8	91
6,3	6,3	45	53	8	91
6,35	6,35	45	53	8	91
6,4	6,4	45	53	8	91
6,5	6,5	45	53	8	91
6,55	6,55	45	53	8	91
6,6	6,6	45	53	8	91
6,65	6,65	45	53	8	91
6,7	6,7	45	53	8	91
6,8	6,8	45	53	8	91
6,9	6,9	45	53	8	91
7	7	45	53	8	91
7,1	7,1	45	53	8	91
9/32	7,14375 (9/32 ")	45	53	8	91
7,2	7,2	45	53	8	91
7,3	7,3	45	53	8	91
7,4	7,4	45	53	8	91
7,45	7,45	45	53	8	91
7,5	7,5	45	53	8	91
7,6	7,6	45	53	8	91
7,65	7,65	45	53	8	91
7,7	7,7	45	53	8	91
7,8	7,8	45	53	8	91
7,9	7,9	45	53	8	91
5/16	7,9375 (5/16 ")	45	53	8	91
8	8	45	53	8	91

BCU1-D01-0224	D1	L2	L3	D2	L1
	 mm ∅	 mm	 mm	 mm ∅	 mm
8,1	8,1	51	61	10	103
8,2	8,2	51	61	10	103
8,3	8,3	51	61	10	103
8,4	8,4	51	61	10	103
8,5	8,5	51	61	10	103
8,6	8,6	51	61	10	103
8,7	8,7	51	61	10	103
11/32	8,73125 (11/32 ")	51	61	10	103
8,8	8,8	51	61	10	103
8,9	8,9	51	61	10	103
9	9	51	61	10	103
9,1	9,1	51	61	10	103
9,2	9,2	51	61	10	103
9,3	9,3	51	61	10	103
9,35	9,35	51	61	10	103
9,4	9,4	51	61	10	103
9,5	9,5	51	61	10	103
3/8	9,525 (3/8 ")	51	61	10	103
9,6	9,6	51	61	10	103
9,65	9,65	51	61	10	103
9,7	9,7	51	61	10	103
9,8	9,8	51	61	10	103
9,9	9,9	51	61	10	103
10	10	51	61	10	103
10,1	10,1	58	71	12	118
10,2	10,2	58	71	12	118
10,3	10,3	58	71	12	118
13/32	10,3187 (13/32 ")	58	71	12	118
10,4	10,4	58	71	12	118

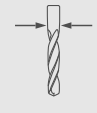
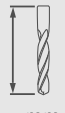
	D1  mm ∅	L2  mm	L3  mm	D2  mm ∅	L1  mm
10,5	10,5	58	71	12	118
10,6	10,6	58	71	12	118
10,7	10,7	58	71	12	118
10,8	10,8	58	71	12	118
10,9	10,9	58	71	12	118
11	11	58	71	12	118
11,1	11,1	58	71	12	118
7/16	11,1125 (7/16 ")	58	71	12	118
11,2	11,2	58	71	12	118
11,3	11,3	58	71	12	118
11,4	11,4	58	71	12	118
11,5	11,5	58	71	12	118
11,6	11,6	58	71	12	118
11,7	11,7	58	71	12	118
11,8	11,8	58	71	12	118
11,9	11,9	58	71	12	118
12	12	58	71	12	118
12,2	12,2	62	77	14	124
12,5	12,5	62	77	14	124
12,7	12,7	62	77	14	124
12,8	12,8	62	77	14	124
13	13	62	77	14	124
13,1	13,1	62	77	14	124
13,2	13,2	62	77	14	124
13,5	13,5	62	77	14	124
13,8	13,8	62	77	14	124
14	14	62	77	14	124



Download Catalog Pages (PDF)





Dimension	Ø2,5 - Ø3	Ø3,1 - Ø4	Ø4,1 - Ø5	Ø5,1 - Ø6	Ø6,1 - Ø7,5	Ø7,6 - Ø9	Ø9,1 - Ø10,5	Ø10,6 - Ø12	Ø12,2 - Ø14
Depth (mm)	L2	L2	L2	L2	L2	L2	L2	L2	L2
Application									

	Material	Strength (N/mm ²)	Feed (mm/r)	fu	fu	fu	fu	fu	fu	fu	fu	fu
P STEEL			Vc (m/min)									
1.1	unalloyed	<500	190	0,095	0,115	0,14	0,16	0,2	0,22	0,25	0,27	0,29
1.2-1.5	unalloyed	<1100	170	0,09	0,11	0,13	0,15	0,19	0,21	0,24	0,27	0,28
2.1-2.2	low alloyed	<950	130	0,09	0,11	0,13	0,15	0,19	0,21	0,24	0,27	0,28
2.3-2.4	low alloyed	<1300	90	0,085	0,1	0,12	0,14	0,18	0,2	0,23	0,25	0,27
3.1-3.2	high alloyed	<1100	110	0,085	0,1	0,12	0,14	0,18	0,2	0,23	0,25	0,27
3.3	high alloyed	<1400	85	0,075	0,09	0,11	0,13	0,17	0,19	0,22	0,24	0,26
K CASTINGS			Vc (m/min)									
1.1-1.2	grey cast iron	<1000	150	0,11	0,13	0,15	0,17	0,21	0,23	0,26	0,28	0,3
M STAINLESS STEEL			Vc (m/min)									
1.1	ferritic/martensitic	<850	110	0,065	0,08	0,09	0,11	0,13	0,15	0,17	0,19	0,2
2.1	austenitic	<650	90	0,06	0,07	0,08	0,1	0,12	0,13	0,14	0,16	0,18
2.2	austenitic	<750	80	0,06	0,07	0,08	0,1	0,12	0,13	0,14	0,16	0,18
3.1	DUPLEX STEEL super austenitic	<1100	80	0,05	0,058	0,067	0,09	0,11	0,12	0,13	0,145	0,16
N NON-FERROUS			Vc (m/min)									
1.1-2.3	ALUMINIUM alloyed/cast	<600	200	0,14	0,15	0,16	0,17	0,18	0,2	0,23	0,26	0,28
3.1-3.3	COPPER alloyed	<600	100	0,06	0,07	0,08	0,105	0,12	0,13	0,14	0,16	0,18
T TITANIUM			Vc (m/min)									
2.1-2.2	pure/alloyed	<1000	35	0,06	0,07	0,08	0,1	0,11	0,12	0,13	0,15	0,16
S SUPER ALLOYS			Vc (m/min)									
1.1-1.3	HRSA	<1450	20	0,03	0,05	0,065	0,08	0,1	0,12	0,13	0,14	0,15

HINWEIS | Nebenanwendung sind in Türkis abgebildet!
 Maximalen IKZ-Druck verwenden.
 Bei Verwendung von Luftkühlung, bitte nur Luft durch die Spindel.
 Luftkühlung eignet sich nur bedingt, das heißt das Werkzeug benötigt nach einer gewissen Anzahl an Bohrungen etwas Zeit, um sich abzukühlen.

LEGENDE

ANWENDUNGEN

 Abzeilen	 Besäumen	 Entgraten	 Gravieren
 Viertelkreisfräsen	 Vollnut	 Vorwärts-Rückwärtsentgraten	 Zustellung Z





KÜHLUNGEN

 Luftgekühlt	 Trocken	 Öl	 Kühlschmierstoff (KSS)
 Minimalmengenschmierung (MMS)			

EIGENSCHAFTEN







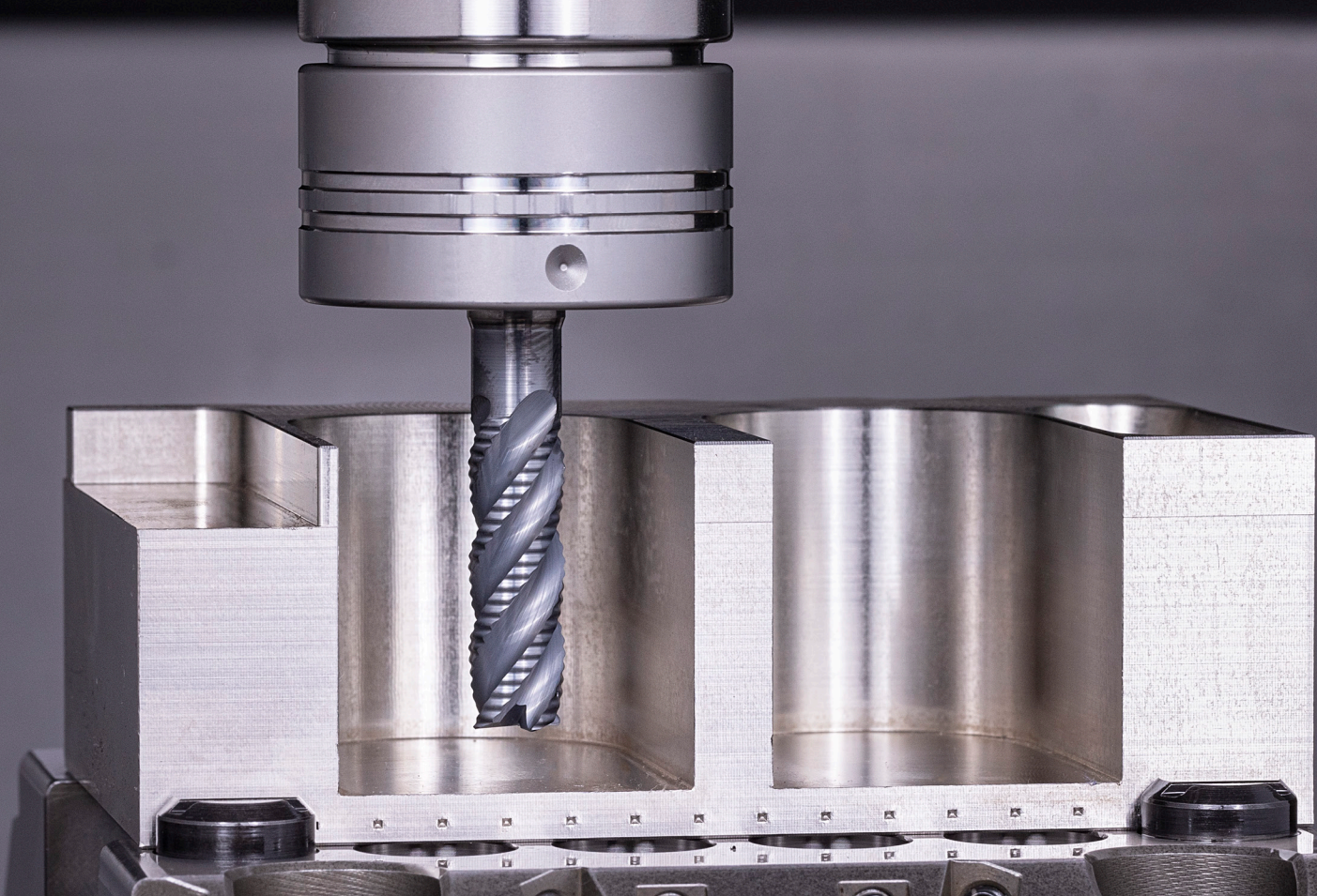









 0,5xD	 1xD	 1,5xD	 2xD
 2,5xD	 3xD	 3,5xD	 4xD
 5xD	 8xD	 Zentrumschneidend	 Nicht Zentrumschneidend
 HA	 HB	 HE	 Kühlkanalsystem
 Verdralte Innenkühlung	 Dynamische Drallsteigung	 Spanbrecher	 Ungleiche Zahnteilung
 Wellenschliff	 Zustellung helikal	 Zustellrichtungen x,y	 Zustellrichtungen x, y, z
 Zustellrichtungen x, y, (z)	 Zustellrichtung z	 Eckenradius	 Eckfase
 Scharfkantig	 60° Spitze	 90° Spitze	 140° Spitze

STRATEGIE

 ETC	 HPC	 HSC	 MTC
 UNI			



EIGENSCHAFTEN

 Schneiddurchmesser	 Kleiner Schneiddurchmesser	 Großer Schneiddurchmesser	 Freistichdurchmesser
 Schneidlänge	 Gesamtfasenlänge	 Freistichlänge	 Gesamtlänge
 Schaftdurchmesser	 Schneidanzahl	 Eckradius	 Eckfase
 Programmierradius	 Maximale Schnitttiefe	 Spiralwinkel	 Winkel Alpha
 Nutlänge			

ANWENDUNGSTABELLE

Bei den angegebenen Werten der Anwendungstabelle handelt es sich lediglich um Richtwerte. Diese sind stark abhängig von der individuellen Anwendungssituation.

ABBILDUNGEN

Alle abgebildeten technischen Zeichnungen und Fotografien sind beispielhaft. Abweichungen zum Originalprodukt bei Farbe und Abmessungen sind möglich.

P 1.1 **STEEL | unalloyed <500 N/mm²**

Materialnumber	Germany DIN	Europe EN	France AFNOR	Great Britain BS	Italy UNI	Sweden SIS	Spain UNE	Japan JIS	USA AISI
1.0498	ST42.8							STPT 42	
1.0044	ST442		E28-2	4360-43 B	Fe 430 BFN	1412	AE 275-B	SM 41 B	570 Gr. 40
1.0420	GS38	GE 200	230-400M			1306			
1.0446	GS45	GE 230	E23-45M	A1		1305	F.221	SC 450	
1.0136	St42-3								
1.0254	St37.0	P235T1						STPG 38	
1.1120	GS20Mn5							SMnC 420	
1.1121	Ck10	2 C 10	XC 10	040 A 10	C 10	1265	C 10 k	S 10 C	1010
1.1131	GS15Mn5								
1.1151	Ck22	2 C 22	XC 25	050 A 20	C 20		C 25 k	S 22 C	1023
1.5523	19MnB4			170 H 20			20 Mn B 4 DF	SWRCHB	
1.8961	WTSt373				Fe 360 D FF			SMA 50 A	
1.0035	ST33		A 33		FE 320			SS 330	
1.0037	ST37-2							STKR 400	
1.0710	15S10								
1.0715	9SMn28	11 SMn 28	S 250	230 M 07	CF 9 SMn 28	1912	11 SMn 28	SUM 22	1213
1.0718	9SMnPb28	11 SMnPb28	S 250 Pb		CF 9SMnPb 28	1914	11 SMnPb 28	SUM 22 L	12 L 13
1.0721	10S20	10 S 20	10 F 1	210 M 15	CF 10 S 20		10 S 20		1108
1.0722	10SPb20	10 SPb 20	10 Pb F 2		CF 10 SPb 20		10 SPb 20		11 L 08
1.0736	9SMn36		S300	240 M 07	CF 9 SMn 36		12 SMn 35	SUM 25	1215
1.0737	9SMnPb36		S 300 Pb		CF 9 SMnPb 36	1926	12 SMnPb 35		12 L 14

P 1.2 **STEEL | unalloyed <700 N/mm²**

Materialnumber	Germany DIN	Europe EN	France AFNOR	Great Britain BS	Italy UNI	Sweden SIS	Spain UNE	Japan JIS	USA AISI
1.0553	S244J0	S355J0	E 36-3	En 50 C	Fe 510 C FN			SM 520 M	S355J0
1.0581	ST52.4							STS 49	
1.1140	C15R	C15R	C15R	C15R			C 16 k-1		
1.1141	Ck15	2 C 15	XC 15	080 M 15	C 15	1370	C 16 k	S 15 C	1015
1.1190	S355G15								
1.0116	ST373		E 24-3	4360-40 C	Fe 37-3	1312	A 360 C		A 570 Gr. 36
1.0144	ST443		E 28-3	4360-43 C	Fe 430 D FF	1414	AE 275-D	SM 41 B	A 573 Gr. 70
1.0401	C15		CC12	080 M 15	C 15	1350	F.111	S 15 C	1015
1.0402	C22	1 C 22	CC 22	070 M 20	C 22		C 22 k	SFVC 1	
1.0406	C25	1 C 25	CC 25	070 M 26	C 25		C 25 k	S 22 C	1025
1.0461	STE255								
1.0482	19Mn5		A 52 CP	224-460				SG 37	
1.0486	STE285				FE E 285 KG		AE 285 KG	SM 41 A	
1.0501	C35	1 C 35	CC 35	060 A 35	C 35	1550	F.113	S 35 C	1035
1.0503	C45	1 C 45	CC 45	080 M 46	C 45	1650	C 45 k	S 45 C	1045
1.0505	STE315							SM 50 A	
1.0511	C40	1 C 40		080 M 40			F.114.A	S 40 C	1040
1.0528	C30	1 C 30	CC 32	080 M 30	C30			SUP 7	1030
1.0540	C50	1 C 50		080 M 50		1674		S 50 C	1050
1.0552	GS52	GE 260							
1.0558	GS60	GE 300	320-560M	A3	C 45	1606			
1.0562	STE355		E 355 R/FP		Fe E 355 KG	2132	AE 355 KG	SM 50 YB	A 633 Gr. C
1.0711	9S20			220 M 07	CF 9 S 22			G 11120	1212
1.0970	38Si7		41 S 7						
1.1106	ESTE355			P 355 NL 2				STK 500	
1.1127	36Mn6			212 M 36				SMn 443	1141
1.1133	20Mn5			120 M 19	G 22 Mn3		20 Mn 6	SMn 420	1022
1.1169	20Mn6								
1.1520	C70W1				C 70 KU				
1.5637	10Ni14			503	18 Ni 14 KT				A 350-LF 5
1.8962	9CrNiCuP324			WR 50 A				SPA-H	
1.0726	35S20	35 S 20	35 MF 4	212 M 36		1957	F.210G		1140
1.0760	38SMn28	38SMn28	38SMn28	38SMn28			38SMn28		
1.1158	Ck25	2 C 25	XC 25	070 M 26	C 25		C 25 k	S 25 C	1025
1.1178	Ck30	2 C 30	XC 32	080 M 30	C30			S 30 C	1030
1.1181	Ck35	2 C 35	XC 38 H1	080 M 36	C35	1572	C 35 k	S 35 C	1034
1.1183	Cf35		XC 38 TS	060 A 35	C35	1572		S 35 C	1035
1.1191	Ck45	2 C 45	XC 42	080 M 46	C40		C45 k	S 45 C	1045
1.1206	Ck50	2 C 50		080 M 50	C50	1674		S 50 C	1050
1.1730	C45W	C 45 U	Y3 42						
1.5423	16Mo5			1503-245-420	16 Mo 5		16 Mo 5	SBC 690	4520

P 1.3 **STEEL** | unalloyed <850 N/mm²

Materialnumber	Germany DIN	Europe EN	France AFNOR	Great Britain BS	Italy UNI	Sweden SIS	Spain UNE	Japan JIS	USA AISI
1.1165	G530Mn5		35 M 5	120 M 36		1330	30 Mn 5	SMn 433 H	1330
1.1525	C80W1	C 80 U	Y1 90		C 80 KU	1880	F.513		W 108
1.1545	C105W1	C 105 U	Y1 105	BW 1A	C 100 KU	1880	F.515		W 110
1.1620	C70W2	C 70 U							
1.1625	C80W2		Y1 80	BW 1B	C 80 KU		C 80	SKC 3	W 1
1.1645	C105W2						C 102	SK 3	
1.1663	C125W	C 120 U	Y2 120		C 120 KU		C 120	SK 2	W 112
1.1673	C135W		Y2 140		C 140 KU			SK 1	
1.1740	C60W		Y3 55					SK 7	
1.1820	C55W								
1.1830	C85W	C 90 U	Y3 90					SK 5	1084
1.1744	C67W		Y1 70				F.512		A-6
1.1750	C75W			BW 1A					W 1
1.5404	21MoV53								
1.5406	17MoV84								
1.5633	24Ni8	G 9 Ni 10	22 N 8		G 9 Ni 10			SCPL 21	
1.6311	20MnMoNi45	20 MnMoNi 4 5						SOV 2 B	
1.7242	16CrMo4	18 CrMo 4	15 CD 3.5		18 CrMo 4		18 CrMo 4	SCM 418 H	
1.7258	24CrMo4							SCM 822 H	
1.7259	26CrMo7								
1.7273	24CrMo10								
1.7337	16CrMo44				A18 CrMo 4 5 KW				A 387 Gr. 12 Cl. 2
1.7350	22CrMo44								
1.7362	12CrMo195	X 12 CrMo 5	Z 10 CD 5.05	3606-625	16 CrMo 20 5			SCMV 6	
1.7709	21CrMoV57	21 CrMoV 5 7	20 CDV 5.07						
1.7766	17CrMoV10								
1.7779	20CrMoV135								

P 1.4 **STEEL** | unalloyed <950 N/mm²

Materialnumber	Germany DIN	Europe EN	France AFNOR	Great Britain BS	Italy UNI	Sweden SIS	Spain UNE	Japan JIS	USA AISI
1.0062	ST601								
1.0532	ST522	S 390 G 1 S							
1.0535	C55	1 C 55	C 55	070 M 55	C 55	1655		C 55	1055
1.0570	ST523	S 355 J2 F3	E 36-3	4360-50 B	Fe 510 B	2132	A 510 C	SM 50 YB	
1.0728	60S20	60 S 20	60 MF 4						1151
1.1203	Ck55	2 C 55	XC 55 H1	070 M 55	C 55	1655	C 55 k	S 55 C	1055
1.7276	10CrMo11		12 CD 10						
1.7281	16CrMo93		20 CD 8						

P 1.5 **STEEL** | unalloyed <1100 N/mm²

Materialnumber	Germany DIN	Europe EN	France AFNOR	Great Britain BS	Italy UNI	Sweden SIS	Spain UNE	Japan JIS	USA AISI
1.0070	ST702		A 70-2		Fe 70-2		A 690-2		
1.0601	C60	1 C 60	AF 70 C 55	080 A 62	C 60			S 60 C-CSP	1060
1.1221	Ck60	2 C 60	XC 60	060 A 62	C 60	1678		S 58 C	1060
1.1223	Cm60	3 C 60	C 60 R	080 A 67	C 60 R				
1.0603	C67W								

P 2.1 **STEEL | low alloyed <750 N/mm²**

Materialnumber	Germany DIN	Europe EN	France AFNOR	Great Britain BS	Italy UNI	Sweden SIS	Spain UNE	Japan JIS	USA AISI
1.0961	60SiCr7	60 SiCr 8	60 SC 7	250 A 61	60 SiCr 8		60 SiCr 8	SUP 7	9262
1.2101	62SiMnCr4								
1.2162	21MnCr5	21 MnCr 5	20 NC 5					SCR 420 H	
1.2208	31CrV3								
1.2210	115CrV3	107 CrV 3 KU	100 C 3		107 CrV 3 KU		F.520.L		L2
1.2235	80CrV2						F.520.J		
1.2241	51CrV4	51 CRMnV 4			51 CrMnV 4 KU				S6
1.2307	29CrMoV9								
1.2323	48CrMoV67		45 CDV 6						
1.2382	GX155CrVMo121								
1.2414	120W4						F.532		
1.2542	45WCrV7	45 WCrV 8		BS 1	45 WCrV 8 KU	2710	45 WCrSi 8		S1
1.2552	80WCrV8						60 WCrSi 8		
1.2726	26NiCrMoV5								
1.2737	28NiCrV5								
1.2738	40CrMnNiMo864	40CrMnNiMo8-6-4							
1.2826	60MnSi4		60 MSC 4						
1.2838	145V33								
1.2842	90MnCrV8	90 MnV 8	90 MV 8	BO 2	90 MnVCr 8 KU				0 2
1.5752	14NiCr14	13 NiCr 12	16 NC 12	655 M 13	16 NiCr 11			SNC 815 H	E3310
1.5919	15CrNi6	14 CrNi 6	16 NC 6	S 107	16 CrNi 4			SNCM 420	
1.7003	38Cr2	38 Cr 2 KD	38 C 2	120 M 36	38 Cr 3		38 Cr 3	SMn 438	50 B40
1.7012	13Cr2								
1.7045	42Cr4	40 NiCrMo 3	42 C 4 TS	530 A 40	41 Cr 4	2245	42 Cr 4	SCr 440	5140
1.7103	67SiCr5	67 SiCr 5			67 SiCr 5				
1.7131	16MnCr5	16 MnCr 5 KD	16 MC 5	527 M 17	16 MnCr 5	2173	16 MnCr 5	SCR 415	5115
1.7271	23CrMoB33								
1.7715	14MoV63	14 MoV 6-3		1503-660-440			13 MoCrV 6		
1.8907	STE500							SM 58	
1.8911	ESTE380								

P 2.2 **STEEL | low alloyed <950 N/mm²**

Materialnumber	Germany DIN	Europe EN	France AFNOR	Great Britain BS	Italy UNI	Sweden SIS	Spain UNE	Japan JIS	USA AISI
1.0902	46Si7		45 S7				46 Si 7		
1.0906	65Si7			250 A 61					
1.0985	QSTE500N								
1.1157	40Mn4		35 M 5	150 M 36					1039
1.1167	36Mn5		40 M 5	150 M 36		2120	36 Mn 5		1335
1.1170	28Mn6	28 Mn 6	35 M 5	150 M 17	C 28 Mn		36 Mn 6	SCMn 1	1330
1.1199	49MnV53			280 M 01					
1.2002	125Cr1		Y2 120 C						
1.2003	75Cr1		35 M 5	150 M 36					
1.2004	85Cr1		Y1 100 C 2						
1.2008	140Cr3		Y2 140 C					SKS 8	
1.2056	90Cr3								
1.2057	105Cr4						F.120.J	SKC 11	
1.2108	90CrSi5	P 280 GH			C 100 KU	2092		SFVC 2A	
1.2109	125CrSi5								
1.2127	105MnCr4				100 CrMn 4 KU			SUJ 3	
1.2206	140CrV1		130 C 3						0 6
1.2242	59CrV4								
1.2243	61CrSiV5								
1.2249	45SiCrV6								
1.2303	100CrMo5						F.520.F		L 7
1.2312	40CrMnMoS86		40 CMD 8						
1.2519	110WCrV5						102 WCrV 5		
1.2562	142WV13								
1.2740	28NiCrMoV10								
1.2743	60NiCrMoV124								
1.2747	28NiMo17								
1.2766	35NiCrMo16								
1.2851	34CrAl6								
1.3501	100Cr2		100 C 2						E 50100
1.3503	105Cr4								E51100
1.3505	100Cr6	100 Cr 6	100 C 6	535 A 99	100 Cr 6	2258	100 Cr 6	SUJ 2	E52100
1.3520	100CrMn6	100 Cr Mn 6	100 CM 6				100 CrMn 6		

P 2.3 **STEEL** | low alloyed <1100 N/mm²

Materialnumber	Germany DIN	Europe EN	France AFNOR	Great Britain BS	Italy UNI	Sweden SIS	Spain UNE	Japan JIS	USA AISI
1.2419	105WCr6	105 WCr 5	105 WC 13		107 WcR 5 KU	2140	105 WCr 5	SKS 31	
1.2511	80WCrV3								
1.2515	100WV4							SKS 21	
1.3561	44Cr2	46 Cr 1 KD	44 Cr 2						5046
1.3563	43CrMo4		43 CrMo 4						4142
1.3565	48CrMo4								
1.5023	38Si7								
1.5025	51Si7	50 Si 7			48 Si 7	2090			9259 H
1.5029	71Si7								
1.5085	51Mn7								
1.5094	38MnS6	38 MnS 6							
1.5131	50MnSi4								
1.5141	53MnSi4								
1.5142	60MnSi5								
1.5213	15MnV5								
1.5217	20MnV6								
1.5223	42MnV7								
1.5225	51MnV7								
1.5231	38MnSiVS5								
1.5232	27MnSiVS6								
1.5233	44MnSiVS6								
1.5403	17MnMoV64			1501-261				SBV 3	
1.5526	30MnB4								
1.5710	36NiCr6		30 NC 6	640 A 35				SNC 236	3135
1.5736	36NiCr10		30 NC 11		35 NiCr 9			SNC 631 H	3435
1.5755	31NiCr14		18 NC 13	653 M 31				SNC 836	
1.6225	11NiMn54								
1.6310	20MnMoNi55		18 MND 5						
1.6368	15NiCuMoNb5				3604-591			SBV 2	
1.6511	36CrNiMo4	36 CrNiMo 4	40 NCD 3		816 M 40		35 NiCrMo 4		9840
1.6582	34CrNiMo6	34 CrNiMo 6	35 NCD 6	817 M 40	35 NiCrMo 6 KB	2541	40 NiCrMo 7	SNCM 447	4340
1.6946	30CrMoNiV511								
1.6948	26NiCrMoV115								
1.6971	79Ni1								
1.6972	83Ni1								
1.7038	37CrS4	37 CrS 4						SUP 11	50 B50 H
1.7214	25CrMo4				25 CrMo 4 F				
1.7389	GX12CrMo101								
1.7561	42CrV6								
1.7701	51CrMoV4		51 CDV 4		51 CrMoV 4				
1.7707	30CrMoV9								
1.7711	40CrMoV47	40 CrMoV 4 6	42 CDV 4	1506-670-860				SNB 21-1-5	
1.7725	GS30CrMoV64								
1.7733	24CrMoV55		20 CDV 6		24 CrMoV 5 5				
1.7735	14CrMoV69								
1.7741	42CrMoV73								
1.7755	GS45CrMoV104								
1.7756	GS36CrMoV104	G 36 CrMoV 10 4							
1.8070	21CrMoV511				21 CrMoV 5 11				
1.8159	50CrV4	51 CrV 4	50 CV 4	735 A 50	50 CrV 4	2230	51 CrV 4	SUP 10	6150
1.8212	21CrVMoW12								
1.8521	15CrMoV59								
1.8509	41CrAlMo7	41 CrAlMo 7	40 CAD 6. 12	905 M 39	41 CrAlMo 7	2940	41 CrAlMo 7	SACM 645	E 71400
1.8515	31CrMo12	31 CrMo 12	30 CD 12	722 M 24	31 CrMo 12	2240	31 CrMo 12		
1.8523	39CrMoV139	39 CrMoV 13 9		897 M 39	36 CrMoV 10				
1.8550	34CrAlNi7	34 CrAlMo 5							
1.8827	S460M	S 460 M	E 460	S 460 M	S460M		S460M		

P 2.4 **STEEL | low alloyed <1300 N/mm²**

Materialnumber	Germany DIN	Europe EN	France AFNOR	Great Britain BS	Italy UNI	Sweden SIS	Spain UNE	Japan JIS	USA AISI
1.1273	90Mn4			060 A 96				SUP 4	1090
1.2311	40CrMnMo7			BP 20	35 CrMo 8 KU				P 20
1.2710	45NiCr6								
1.2762	75CrMoNiW67								
1.5864	35NiCr18								
1.6587	17CrNiMo6	17 CrNiMo 7	18 NCD 6	820 A 16	18 NiCrMo 7	2523	14 NiCrMo 13	SNCM 815	
1.7222	42CrMoPb4								
1.7225	42CrMo4.M4S	42 CrMo 4	42 CD 4	708 A 42	42 CrMo 4	2244		SCM 440 H	4140
1.7227	42CrMoS4	42 CrMoS 4	42 CD	708 H 42	42 CrMoS 4	2244	40 CrMo 4		
1.7238	49CrMo4								

P 3.1 **STEEL | high alloyed <800 N/mm²**

Materialnumber	Germany DIN	Europe EN	France AFNOR	Great Britain BS	Italy UNI	Sweden SIS	Spain UNE	Japan JIS	USA AISI
1.2362	X63CrMoV51								
1.2363	X100CrMoV51	X 100 CrMoV 5 1	Z 100 CDV 5	BA 2	X 100 CrMoV 5 1 KU	2260	X 100 CrMoV 5	SKD 12	A 2
1.2367	X38CrMoV53		Z 38 CDV 5 3						
1.2376	X96CrMoV12								
1.2379	X155CrMo121	X 153 CrMoV 12	Z 160 CDV 12	BD 2	X 155 CrMoV 12 1 KU	2310		SKD 11	D 2
1.2453	X130W5								
1.2564	X30WCrV41	30 WCrV 15 1					F.527		
1.2567	X30WCrV53	X 30 WCrV 5 3	Z 32 WCV 5		X 30 WCrV 5 3 KU			SKD 4	
1.2606	X37CrMoW51		Z 35 CWDV 5	BH 12	X 35 CrMoW 05 KU		F.537	SKD 62	H 12
1.2631	X50CrMoW911								
1.2786	X13NiCrSi3615	X 13 CrNiSi 36 15	Z 35 NCS 37-18						
1.2889	X45CoCrMoV553								

P 3.2 **STEEL | high alloyed <1100 N/mm²**

Materialnumber	Germany DIN	Europe EN	France AFNOR	Great Britain BS	Italy UNI	Sweden SIS	Spain UNE	Japan JIS	USA AISI
1.2083	X42Cr13	X 42 Cr 13	Z 40 C 14		X 41 Cr 13 KU	2314		SUS 420 J2	420
1.2316	X36CrMo17	X 36 CrMo 17	X38CrMo 16 1		X 38 CrMo 16 1 KU		X 38 CrMo 16		D-4
1.2343	X38CrMoVH1	X 38 CrMoV 5 1	Z 38 CDV 5	BH 11	X 37 CrMoV 5 1 KU		X 37 CrMoV 5	SKD 6	H 11
1.2344	X40CrMoV51	X 40 CrMoV 5 1	Z 40 CDV 5	BH 13	X 40 CrMoV 5 1 1 KU	2242	X 40 CrMoV 5	SKD 61	H 13
1.2436	X210CrW12	X 210 CrW 12	Z 210 CW1 2		X 215 CrW 12 1 KU	2312	X 210 CrW 12	SKD 2	
1.2581	X30WCrV93	X 30 WCrV 9 3	Z 30 WCV 9	BH 21	X 30 WCrV 9 3 KU		X 30 WCrV 9	SKD 5	H 21
1.2601	X165CrMoV12	X 165 CrMoV 12			X 165 CrMoW 12 KU	2310	X 160 CrMoV 12		
1.2622	X60WCrMoV94								
1.2678	X45CrCoVW555								H 19
1.2731	X50NiCrW1313								
1.2764	X19NiCrMo4								
1.2767	X45NiCrMo4	40 NiCrMo 4	Y 35 NCD 16		42 NiCrMo 15 7 KU				A 9
1.2779	X6NiCrTi2615			S 66286					660
1.2787	X23CrNi17	HS 6-5-2	Z 85 WDCV 06 05 04 02	BM 2	HS 6 5 2 2	2722		SKH 9	
1.3302	S1214	HS 12 1 4			X 150 WV 1305 KU				A 7
1.3318	S1212	HS 02.01.12							
1.3401	X120Mn12	X 120 Mn 12	Z 120 M 12	BW 10	X G 120 Mn 12	2183	AM-X 120 Mn 12	SCMnH 1	A 128
1.3543	X102CrMo17	X 102 CrMo 17	X100CrMo17		X 105 CrMo 17		X 100 CrMo 17		
1.3549	X89CrMoV81								
1.3551	80MoCrV4216		80 DCV 40	T 11350	X 80 MoCrV 4 4		80 MoCrV 40-16		M 50

P 3.3 **STEEL** | high alloyed <1400 N/mm²

Materialnumber	Germany DIN	Europe EN	France AFNOR	Great Britain BS	Italy UNI	Sweden SIS	Spain UNE	Japan JIS	USA AISI
1.2709	X3NiCoMoTi1895								
1.2790	72SiNiCrMoV54								
1.2888	X20CoCrWMo109								
1.3202	S12145	HS12-1-5-5		BT 15	HS 12-1-5-5		12-1-5-5		T 15
1.3207	S104310	HS10-4-3-10	Z130WKCDV10-10-04-04	BT 42	HS 10-4-3-10		10-4-3-10	SKH 57	M 44
1.3243	S6525	HS6-5-2-5	KCV 06-05-05-04-02		HS 6-5-2-5	2723	6-5-2-5	SKH 55	M 35
1.3246	S7425	HS1-8-1	Z110 WKCDV 07-05-04	T 11341	HS 7-4-2-5		7-4-2-5		M 41
1.3247	S21018	HS2-9-1-8	Z110 DKCWV 09-08-04	BM 42	HS 2-9-1-8		2-10-1-8		M 42
1.3249	S2928			BM 34			2-9-2-8		
1.3255	S18125	HS18-1-1-4	Z80 WKCV 18-05-04-01	BT 4	HS 18-1-1-5		18-1-1-5	SKH 3	T 4
1.3257	S181215								
1.3265	S181210	HS18-0-1-10		BT 5	HS 18-0-1-10		18-0-2-10	SKH 4A	T 5
1.3342	SC652	HS6-5-2	Z90 WDCV 06-05-04-02		HSC 6-5-3				M 3
1.3343	S652	HS6-5-3	Z85 WDCV 06-05-04-02	BM 2	HS 6-5-2	2722	6-5-2	SKH 51	M2
1.3344	S653		Z120 WDCV 06-05-04-03				6-5-3	SKH 52	M 3 Cl.2
1.3346	S291	HS1-8-1	Z85 DCWV 08-04-02-01	BM 1	HS 1-8-1				M1
1.3348	S292	HS2-9-2	Z100 DCWV 09-04-02-02		HS 2-9-2	2782	2-9-2		M 7
1.3355	S1801	HS18-0-1	Z80 WCV 18-04-01	BT 1	HS 18-0-1		18-0-1	SKH 2	T 1
1.3549	X89CrMoV81								
1.3551	80MoCrV4216		80 DCV 40	T 11350	X 80 MoCrV 4 4		80 MoCrV 40-16		M 50

K 1.1 **GREY CAST IRON** <600 N/mm² (180 HB)

Materialnumber	Germany DIN	Europe EN	France AFNOR	Great Britain BS	Italy UNI	Sweden SIS	Spain UNE	Japan JIS	USA AISI
0.6010	GG10	GJL-100	FGL 100	Grade 100	G 10	0110-00	FG 10	FC 100	A48-20 B
0.6012	GG150 HB	GJL-HB 170							
0.6015	GG15	GJL-150	FGL 150	Grade 150	G 15	0115-00	FG 15	FC 150	A48-25 B
0.6017	GG170 HB	GJL-HB 205							

K 1.2 **GREY CAST IRON** <1000 N/mm² (300 HB)

Materialnumber	Germany DIN	Europe EN	France AFNOR	Great Britain BS	Italy UNI	Sweden SIS	Spain UNE	Japan JIS	USA AISI
0.6020	GG20	GJL-200	FGL 200	Grade 220	G 20	0120-00	FG 20	FC 200	A48-30 B
0.6022	GG190 HB	GJL-HB 230							
0.6025	GG25	GJL-250	FGL 250	Grade 260	G 25	0125-00	FG 25	FC 250	A48-40 B
0.6027	GG220 HB	GJL-HB 250	FGL 250						
0.6030	GG30	GJL-300	FGL 300	Grade 300	G 30	0130-00	FG 30	FC 300	A48-45 B
0.6032	GG240 HB	GJL-HB 275							
0.6035	GG35	GJL-350	FGL 350	Grade 350	G 35	0135-00	FG 35	FC 350	A48-50 B
0.6037	GG260 HB	GJL-HB 275							
0.6040	GG40	GJL-400	FGL 400	Grade 400		0140-00			A48-60 B

M 1.1 STAINLESS STEEL FERRITIC/MARTENSITIC <850 N/mm²

Materialnumber	Germany DIN	Europe EN	France AFNOR	Great Britain BS	Italy UNI	Sweden SIS	Spain UNE	Japan JIS	USA AISI
1.4000	X6Cr13	X 6 Cr 13	Z 6 C 13	403 S 17	X 6 Cr 13	2301	X 6 Cr 13	SUS 403	403
1.4002	X6CrAl13	X 6 CrAl 13	Z 6 CA 13	405 S 17	X 6 CrAl 13	2302	X 6 CrAl 13	SUS 405	405
1.4003	X2CrNi12	X2CrNi12	CLC 4003		F 12N				
1.4005	X12CrS13	X 12 CrS 13	Z 12 CF 13	416 S 21	X 12 CrS 13	2380	X12 CrS 13	SUS 416	416
1.4006	X10Cr13	X 12 Cr 13 KD	Z 12 C 13	410 S 21	X 12 Cr 13	2302	X 12 Cr 13	SUS 410	410
1.4008	GX8CrNi13	GX 7 CrNiMo 12 1	Z 12 CN 13 M	410 C 21	GX 12 Cr 13			SCS 1	414
1.4016	X6Cr17	X 8 Cr 17	Z 8 C 17	430 S 15	X 8 Cr 17 KD	2320	X 8 Cr 17	SUS 430	430
1.4017	X6CrNi171	X 6 CrNi 17 1	F 17 N		X 6 CrNi 17 1				
1.4021	X20Cr13	X 20 Cr 13	Z 20 C 13	420 S 37	X 20 Cr 13	2303	X 20 Cr 13	SUS 420 J1	420
1.4024	X15Cr13	X 15 Cr 13	Z 12 C 13 M	420 S 29	X 12 Cr 13			SUS 410 J1	
1.4027	GX20Cr14		Z 20 C 13 M	420 C 29				SCS 2	
1.4028	X30Cr13	X 30 Cr 13	Z 30 Cr 13	420 S 45	X 30 Cr 13	2304	X 30 Cr 13	SUS 420 J2	420
1.4031	X40Cr13	X 40 Cr 13	Z 40 C 14		X 40 Cr 14	2304	X 40 Cr 13	SUS 420	420
1.4034	X45Cr13	X 45 Cr 13	Z 40 C 14	420 S 45	X 40 Cr 14		X 46 Cr 13	SUS 420	420
1.4057	X19CrNi172	X 19 CrNi 17 2	Z 15 CN 16.02	431 S 29	X 16 CrNi 16	2321	X 15 CrNi 16	SUS 431	431
1.4059	GX22CrNi17		Z 20 CN 17.2 M	ANC 2					
1.4085	GX70Cr29								
1.4086	GX120Cr29			425 C 11					
1.4104	X12CrMoS17	X 14 CrMoS 17	Z 10 CF 17	441 S 29	X 10 CrS 17	2383	X 10 CrS 17	SUS 430 F	430 F
1.4105	X4CrMoS18	X 6 CrMoS 17	Z 6 CDF 18-02					SUS 430 F	430
1.4106	X10CrMo13								
1.4107	GX8CrNi12	GX 8 CrNi 12	GX 8 CrNi 12		GX 8 CrNi 12				
1.4108	X100CrMo13								
1.4109	X65CrMo14	X 70 CrMo 15	Z 70 CD 14					SUS 440 A	440 A
1.4110	X55CrMo14		Z 50 CD 13						
1.4111	X110CrMoV15		Z 4 CN b 17		X 6 CrNb 17			SUS 430 LX	
1.4112	X90CrMoV18	X 90 CrMoV 18	Z 3 CT 1 2	409 S 1 9	X 6 Cr Ti 1 2			SUS 440 B	440 B
1.4113	X6CrMo171	X 8 CrMo 17	Z 8 CD 17.02	434 S 17	X 8 CrMo 17	2325		SUS 434	434
1.4115	X20CrMo171								
1.4116	X45CrMoV15	X 50 CrMoV 15	Z 50 CD 15		X50 CrMoV 15		X 46 CrMo 16		
1.4117	X38CrMoV15								
1.4119	X15CrMo13								
1.4120	X20CrMo13		Z 20 CD 14						
1.4122	X35CrMo17	X 39 CrMo 17 1	X39CrMo17-1		X 35 CrMo 17				
1.4123	X15TN								
1.4125	X105CrMo17	X 105 CrMo 17	Z 100 CD 17		X 105 CrMo 17			SUS 440 C	440 C
1.4136	GX70CrMo292		Z 60 CD 29.2 M						
1.4138	GX120CrMo292								
1.4313	X5CrNi134	X 3 CrNiMo 13 4	Z 4 CDN 13.4	425 C 11	X 3 CrNiMo 13 4	2385		SCS 5	CA 6-NM
1.4317	GX4CrNi134	GX 4 CrNi 13 4	GX 4 CrNi 13 4		GX 4 CrNi 13 4				
1.4351	X3CrNi134	X 3 CrNi 14 04 KE							
1.4405	GX5CrNiMo165	GX 4 CrNiMo 16 5 1	GX 4 CrNiMo 16 5 1		GX 4 CrNiMo 16 5 1				
1.4502	X8CrTi18	X 6 Cr 18 KE							
1.4510	X6CrTi17	X 8 CrTi 17	Z 8 CT 17		X 6 CrTi 17		X 8 CrTi 17	SUS 430 LX	430 Ti
1.4511	X6CrNb17	X 3 CrNb 17	Z 8 CNb 17		X 6 CrNb 17			SUS 430 LX	430 Nb
1.4512	X6CrTi12	X 5 CrTi 12	Z 6 CT 12	409 S 19	X 6 CrTi12			SUH 409	409
1.4523	X8CrMoTi17	X 2 CrMoTiS 18 2	X 2 CrMoTiS 18 2						
1.4528	X105CrCoMo182								
1.4535	X90CrCoMoV17								
1.4543	X3CrNiCuTi129				X 6 CrNiNB 18 11				
1.4704	X45SiCr4	45SiCr16-11							HNV 2
1.4710	GX30CrSi6	GX 30 CrSi 6							
1.4712	X10CrSi6		K 51255						
1.4713	X10CrAlSi7	X 10 CrAlSi 7							
1.4718	X45CrSi93*	X 45 CrSi 8	Z 45 CS 9	401 S 45	X 45 CrSi 8		F.3220	SUH 1	HNV 3
1.4722	X10CrSi13						X 10 CrSi 13		
1.4724	X10CrAl13	X 10 CrAl 13	Z 10 C 13	BH 12	X 10 CrAl 12		X 10 CrAl 13	SUS 405	H-12
1.4725	X8CrAl144	CrAl 14 4	K 91670						
1.4729	GX40CrSi13				GX 35 Cr 13			SCH 1	
1.4740	GX40CrSi17				GX 35 Cr 17				
1.4742	X10CrAl18		Z 10 CAS 18	403 S 15	X 8 Cr 17		X 10 CrAl 18	SUH 21	430
1.4745	GX40CrSi23								
1.4747	X80CrNiSi20	X 80 CrNiSi 20	Z 80 CSN 20.02	433 S 65	X 80 CrSiNi 20		X 80 CrSiNi20-02	SUH 4	HNV 6
1.4762	X10CrAl24	X 10 CrAl 24	Z 10 CAS 24		X 16 Cr 26	2322	X 10 CrAl 24	SUH 442	446
1.4767	X8CrAl205	CrAl 20 5							
1.4773	X8Cr30								
1.4776	GX40CrSi29			452 C 11	GX 35 Cr 28			SCH 2	

M 2.1 STAINLESS STEEL | austenitic <650 N/mm²

Materialnumber	Germany DIN	Europe EN	France AFNOR	Great Britain BS	Italy UNI	Sweden SIS	Spain UNE	Japan JIS	USA AISI
1.4300	X12CrNi188			302					
1.4301	X5CrNi1810	X 6 CrNi 18 10 KD	Z 6 CN 18.09	304 S 15	X 5 CrNi 18 10	2332	X 5 CrNi 18 11	SUS 304	304 H
1.4302	X5CrNi199	X 6 CrNi 20 10 KE		308 S 96					
1.4303	X5CrNi1812	X 8 CrNi 18 12 KD	Z 8 CN 17.07	305 S 19	X 8 CrNi 19 10		X 8 CrNi 18 12	SUS 305	308
1.4305	X10CrNiS189	X 8 CrNiS 19 9	Z 8 CNF 18.09	303 S 31	X 8 CrNiS 18 9	2346	F.310.C	SUS 303	303
1.4307	X2CrNi189	X 2 CrNi 18 9	CLC 18.9.L	304 S 11	X 2 CrNi 18 9			SUS 304 L	304 L
1.4308	GX6CrNi189	X 2 CrNi 18 7	Z 6 CN 18.10 M	304 C 15	GX 5 CrNi 19 10	2333		SCS 13	CF-8
1.4310	X12CrNi177	X 12 CrNi 17 7	Z 12 CN 17.07	301 S 21	X 12 CrNi 17 07		X 12 CrNi 17 07	SUS 301	301
1.4311	X2CrNiN1810	X 2 CrNiN 18 10	Z 8 CN 18.12	304 S 62	X 8 CrNi 19 10	2371	X 8 CrNi 18 12	SUS 304 LN	304 LN
1.4312	GX10CrNi188		Z 10 CN 18.9 M	302 C 25				SCS 12	
1.4318	X 2 CrNiN 18 7	X 2 CrNiN 18 7	18-7L		18-7L				
1.4319	X3CrNiN178			302 S 26	X 10 CrNi 18 09			SUS 302	
1.4350	X5CrNi189		Z 6 CN 18.09	304 S 31	X 5 CrNi 18 10				304
1.4401	X5CrNiMo17122	X 6 CrNiMo 17 12 2 KD	Z 6 CND 17.11	316 S 16	X 5 CrNiMo 17 12	2347	X 5 CrNiMo 17 12	SUS 316	316
1.4404	X2CrNiMo17132	GX 3 CrNiMo 17 12 2 KD	Z 3 CND 19.10 M	316 S 12	GX 2 CrNiMo 19 11	2348	X 2 CrNiMo	SUS 316 L	316 L
1.4406	X2CrNiMoN17122	X 3 CrNiMoN 17 12 2	Z 2 CND 17.12 Az	316 S 61	X 2 CrNiMoN 17 12			SUS 316 LN	316 LN
1.4407	GX 5 CrNiMo 13 4	GX 5 CrNiMo 13 4	J 91550						A757
1.4408	GX6CrNiMo1810	GX 5 CrNiMo 19 11 2	GX 5 CrNiMo 19 11 2	316 C 16	GX 5 CrNiMo 19 11 2	2343	X 7 CrNiMo 20 10	SCS 14	CF-8M
1.4435	X2CrNiMo18143	X 2 CrNiMo 18 16	Z 2 CDN 17.13	316 S 11	X 2 CrNiMo 17 13	2353		SVS 16	316 L
1.4436	X5CrNiMo17133	X 6 CrNiMo 18 13 3 KD	Z 6 CND 17.12	316 S 16	X 5 CrNiMo 17 13	2343	X 6 CrNiMo 17 12 03	SUS 316	316
1.4438	X2CrNiMo18164	X 3 CrNiMo 18 16 4	Z 2 CND 19.15	317 S 12	X 2 CrNiMo 18 15	2367		SUS 317 L	317 L
1.4440	X2CrNiMo18165								
1.4442	X2CrNiMo18154		X 3 CrNiMoN 18 14						

M 2.2 STAINLESS STEEL | austenitic <750 N/mm²

Materialnumber	Germany DIN	Europe EN	France AFNOR	Great Britain BS	Italy UNI	Sweden SIS	Spain UNE	Japan JIS	USA AISI
1.4429	X2CrNiMoN17133	X 3 CrNiMoN 17 12 2	Z 2 CND 17.13 Az	316 S 62	X 2 CrNiMoN 17 13	2375		SUS 316 LN	316 LN
1.4432	X2CrNiMo17123	X 2 CrNiMo 17 12 2	Z 3 CND 17 13 30	316 S 13	X 2 CrNiMo 17 12 3			SUS 316L	316 L
1.4434	X2CrNiMoN18124		CLC 18.12.4.LN		X 2 CrNiMoN 18 12 4				317 LN
1.4439	X2CrNiMoN17135	X 3 CrNiMo 17 13 5	Z 3 CnD 18.14-05 Az						
1.4465	X1CrNiMoN25252								
1.4505	X5NiCrMoCuNb2018								
1.4506	X5NiCrMoCuTi2018								
1.4529	X1NiCrMoCuN25206								
1.4536	GX2NiCrMoCuN2520	GX 2 CrNiMoCuN 25 20 6							
1.4539	X1NiCrMoCuN25205	X 1 NiCrMoCu 25 20 5	Z 1 NCDU 25.20	904 S 13		2662			
1.4541	X6CrNiTi1810	X 6 CrNiTi 18 10	Z 6 CNT 18.10	321 S 12	X 6 CrNiTi 18 11	2337	X 7 CrNiTi 18 11	SUS 321	321
1.4542	X5CrNiCuNb164	X 5 CrNiCuNb 16 4	Z 7 CNU 17.04		X 5 CrNiCuNb 16 4			SUS 630	630
1.4550	X6CrNiNb1810	X 6 CrNiNb 18 10	Z 6 CNNb 18.10	347 S 17	X 6 CrNiNb 18 11	2338	X 6 CrNiNb 18 11	SUS 347	347
1.4551	X5CrNiNb199	X 5 CrNiNb 20 10 KE	Z 6 CNNb 20-10					SUS 347 Y	
1.4552	GX5CrNiNb189	GX 5 CrNiNb 19 11	Z 4 CNNb 19.10 M	347 C 17	GX 5 CrNiNb 19 11			SCS 21	
1.4571	X6CrNiMoTi17122	X 6 CrNiMoTi 17 12 2	Z 6 CNDT 17.12	320 S 31	X 6 CrNiMoTi 17 12	2350	X 6 CrNiMoTi 17 12.03	SUS 316 Ti	316 Ti
1.4573	X10CrNiMoTi812			320 S 33	X 6 CrNiMoTi 17 13			SUS 316 Ti	316 Ti
1.4575	X2CrNiMoNb2842								
1.4577	X3CrNiMoTi2525								
1.4580	X6CrNiMoNb17122	X 6 CrNiMoNb 17 12 2	Z 6 CNDNb 17.12	318 S 17	X 6 CrNiMo 17 12 2				316 Cb
1.4581	GX5CrNiMoNb1810	GX 5 CrNiMoNb 19 11 2	Z 4 CNDNb 18.12 M	318 C 17	GX 6 CrNiMoNb 20 11			SCS 22	
1.4582	X4CrNiMoNb257							SCS 22	
1.4583	X10CrNiMoNb1812				X 6 CrNiMoNb 17 13				318
1.4585	GX7CrNiMoNb257								
1.4586	X5CrNiMoCuNb2218								
1.4821	X20CrNiSi254	X 20 CrNiSi 25 4	Z 20 CNS 25.04			2322			
1.4822	GX40CrNi245		J 92605	J 92605					
1.4823	GX40CrNiSi274								
1.4825	GX25CrNiSi189			302 C 35	GX 16 CrNi 20 10				
1.4826	GX40CrNiSi229							SCH 12	
1.4828	X15CrNiSi2012	X 15 CrNiSi 20 12	Z 15 CNS 20.12	309 S 24	X 16 CrNiSi 20 12		X 15 CrNiSi 20 12	SUH 309	309
1.4833	X7CrNi2314	X 12 CrNi 23 13	Z 15 CN 24.13	309 S 24	X 6 Cni 23 14			SUS 309 S	309 S
1.4837	GX40CrNiSi2512			309 C 30	GX 35 CrNi 25 12			SCS 17	

M 2.2 STAINLESS STEEL | austenitic <750 N/mm²

Materialnumber	Germany DIN	Europe EN	France AFNOR	Great Britain BS	Italy UNI	Sweden SIS	Spain UNE	Japan JIS	USA AISI
1.4841	X15CrNiSi2520	X 15 CrNiSi 25 20	Z 15 CNS 25.20	314 S 25	X 16 CrNiSi 25 20		X 15 CrNiSi 25 20	SUH 310	310
1.4841	X15CrNiSi2520	X 15 CrNiSi 25 20	Z 15 CNS 25.20	314 S 25	X 16 CrNiSi 25 20		X 15 CrNiSi 25 20	SUH 310	310
1.4845	X12CrNi2521	X 8 CrNi 25 21	Z 12 CN 25.20	310 S 24	X 6 CrNi 25 20	2361	F.331	SUS 310 S	310 S
1.4848	GX40CrNiSi2520			310 C 40	GX 40 CrNi 26 20		X 40 CrNi 25 20	SCH 21	HK
1.4861	"	X10NiCr3220*							
1.4866	X33CrNiMnN238	X 33 CrNiMnN 23 8	X 33 CrNiMnN 23 8						
1.4871	X53CrMnNiN219		Z 52 CMN 21.09	349 S 54	X 53 CrMnNiN 21 9		X 53 CrMnNiN 21-09	SUH 35	EV 8
1.4873	X45CrNiW189	X 45 CrNiW 18 9	Z 35 CNWS 14.14	331 S 40	X 45 CrNiW 18 9		X 45 CrNiSiW 18-09	SUH 31	
1.4878	X12CrNiTi189	X 10 CrNiTi 18 10	Z 6 CNT 18.12	321 S 20	X 6 CrNiTi 18.11	2337	X 6 CrNiTi 18 11	SUS 321	321
1.4881	X70CrMnNiN216				X 70 CrMnNiN 21 6				EV 11
1.4882	X50CrMnNiNbN219	X 50 CrMnNiNbN 21 9	Z 50 CMNNb 21.09						
1.4919	X6CrNiMo1713	X 6 CrNiMo 17 12 2	Z 6 CND 17.13 B	316 S 51					316 H
1.4948	X6CrNi1811	X 6 CrNi 18 10	Z 6 CN 18.09	304 S 51	X 5 CrNi 18 10 KW	2333			
1.4949	X3CrNi1811				X 2 CrNiN 18 11				
1.4961	X8CrNiNb1613			347 S 51			X 7 CrNiNb 16 13		
1.4981	X8CrNiMoNb1616						X 7 CrNiMo 16 16		

M 3.1 DUPLEX STEEL | austenitic <1100 N/mm²

Materialnumber	Germany DIN	Europe EN	France AFNOR	Great Britain BS	Italy UNI	Sweden SIS	Spain UNE	Japan JIS	USA AISI
1.4162	X2CrMnNiN2252	X 2 CrMnNiN 22 5 2			X2CrMnNiN21-5-1		S32101	LDX 2101	S321 01
1.4362	X2CrNiN234	X 2 CrNiN 23 4	Z 3 CN 23 04 AZ			2327			S323 04
1.4410	X2CrNiMoN2574	X 2 CrNiMoN 25 7 4	Z 5 CND 20.10 M		X 2 CrNiMoN 25 7 4			SCS 14 A	S327 50
1.4460	X4CrNiMo2752	X 3 CrNiMo 27 5 2	X 2 CrNiMo 25 7 3			2324	X 8 CrNiMo 27 05	SUS 329 J1	S325 50
1.4462	X2CrNiMoN2253	X 2 CrNiMoN 22 5 3	Z 3 CND 22.05 AZ	318 S 13	X 2 CrNiMoN 22 5 3	2377		SUS 329 J3L	S318 03
1.4465	X1CrNiMoN25252	X 1 CrNiMoN 25 25 2	Z 1 CND 25.22 AZ						S310 50
1.4501	X2CrNiMo-CuWN2574	X 2 CrNiMoCuWN 25 7 4	Z 3 CND 25.06 AZ					SM 25 Cr	S327 60
1.4507	X2CrNiMoCuN2563	X 2 CrNiMoCuN 25 6 3	Z 3 CNDU 25.06 AZ					QSA 2505	S325 20
1.4534	13-8 PH	X 3 CrNiMoAl 13 8 2	Z 4 CNDAT 13.09						S138 00
1.4542	17-4 PH	X 5 CrNiCuNb 16 4	Z 7 CNU 17 04					SUS 630	630
1.4545	15-5 PH	X 5 CrNiCu 15 5	Z 6 CNU 15 05						XM-12
1.4548	17-4 PH	X5CrNiCuNb1744	X 5 CrNiCuNb 16 4					SUS 630	S174 00
1.4568	17-7 PH	X 7 CrNiAl 17 7	Z 9 CNA 17 07	301 S 81	X 7 CrNiAl 17 7	2388	X 7 CrNiAl 17 7	SUS 631	S177 00

N 1.1 ALUMINIUM | alloyed <500 N/mm²

Materialnumber	Germany DIN	Europe EN	France AFNOR	Great Britain BS	Italy UNI	Sweden SIS	Spain UNE	Japan JIS	USA AISI
3.1255	AlCu 4 SiMg	AW-2014	A-U4SG	H 15	P-AlCu 4.4 SiMnMg		L-3130	A2014	AA2014
3.1305	AlCu 2.5 Mg	AW-2117	A-U2G	L 86	P-AlCu 2.5 MgSi		L-3180	A2117	AA2117
3.1324	AlCu 4 MgSi	AW-2017 A							
3.1325	AlCuMg1	AW-2017 A	A-U4G	H 14	P-AlCu 4.5 MgMn	GA631	L-3120	A2017	AA2017 A
3.1355	AlCuMg2	AW-2024	A-U4G1	L 97 / L 98	P-AlCu 4.5 MgMn	5	L-3140	A2024	AA2024
3.2315	AlMgSi 1	AW-6082	A-SGM0,7	H 30	P-AlMgSi	4212	L-3453		AA6082
3.3206	AlMgSi 0.5	AW-6060	A-GS	H 9	P-AlMgSi	4140	L-3442		AA6060
3.3208	Al99.9 MgSi	AW-6401							
3.3210	AlMgSi 0.7	AW-6005 A							
3.3211	AlMg 1 SiCu	AW-6061	A-GSUC	H 20	P-AlMg 1 SiCu		L-3420	A6061	AA6061
3.3315	AlMg1	AW-5005 A	A-G0,6	N 41	P-AlMg 0.9	4106	L-3350	A5005	AA5005 A
3.3316	AlMg 1.5	AW-5050	A-G1,5	3L 44	P-AlMg 1.5		L-3380		AA5050 B
3.3317	Al99.85 Mg 1	AW-5305							
3.3318	Al99.9 Mg 1	AW-5505							
3.3326	AlMg 1.8	AW-5051 A							
3.3345	AlMg 4.5	AW-5082	A-G4,5		P-AlMg 4.4			A5082	AA5082
3.3523	AlMg 2.5	AW-5052	A-G2,5C	L 80 / L 81	P-AlMg 2.5	4120	L-3360	A5052	AA5052
3.3525	AlMg 2 Mn 0.3	AW-5251	A-G2M	N4	P-AlMg 2 Mn		L-3361		AA5251
3.3527	AlMg 2 Mn 0.8	AW-5049	A-G2,5MC					A5049	AA5049
3.3535	AlMg 3	AW-5754	A-G3M		P-AlMg 3.5	4130	L-3390		AA5754
3.3537	AlMg 2.7 Mn	AW-5454	A-G2,5MC		P-AlMg 2.7 Mn	4130	L-3391		AA5454
3.3541	G-AlMg 3	AC-51100							
3.3545	AlMg 4 Mn	AW-5086	A-G4MC		P-AlMg 4.4		L-3382		AA5086
3.3547	AlMg 4 Mn	AW-5086	A-G4MC	N8	P-AlMg 4.5	4140	L-3321	A5083	AA5083

N 1.2 ALUMINIUM | alloyed <600 N/mm²

Materialnumber	Germany DIN	Europe EN	France AFNOR	Great Britain BS	Italy UNI	Sweden SIS	Spain UNE	Japan JIS	USA AISI
3.0615	AlMgSiPb	AW-6012	A-SGPb		P-AISiMgMn		L-3452		AA6012
3.1645	AlCu 4 PbMgMn	AW-2007				4355	L-3121	A2007	AA2007
3.1655	AlCu 6 BiPb	AW-2011	A-U5PbBi	FC 1	P-AlCu 5.5 PbBi	4338	L-3192	A2011	AA2011
3.4335	AlZn 4.5 Mg 1	AW-7020	A-Z5G	H 17		4425	L-3741		AA7020
3.4345	AlZnMgCu 0.5	AW-7022	A-Z4GU						AA7022
3.4365	AlZnMgCu 1.5	AW-7075	A-Z5GU	2L 95	P-AlZn 5.8 MgCu		L-3710	A7075	AA7075

N 2.1 - 2.3 ALUMINIUM | cast <600 N/mm²

Materialnumber	Germany DIN	Europe EN	France AFNOR	Great Britain BS	Italy UNI	Sweden SIS	Spain UNE	Japan JIS	USA AISI
3.2151	G-AlSi 6 Cu 4	AC-45000	A-S5UZ	LM 4				AC4B	A 319.0
3.2161	G-AlSi 8 Cu 3	AC-46200	A-S9U3A-Y4	LM 24	5075			AC4D	A 328.0
3.2371	G-AlSi 7 Mg 0,3	AC-42100						AC4CH	A 356.0
3.2373	G-AlSi 9 Mg	AC-43300							
3.2381	G-AlSi 10 Mg	AC-43100							
3.2383	G-AlSi 10 Mg(Cu)	AC-43400	A-S10G	LM 9	3049	4253		ADC3	A 360.2
3.2581	G-AlSi 12	AC-47100	A-S13	LM 6	4514	4261		AC3A	A 413.2
3.2583	G-AlSi 12 Cu	AC-44300	A-S12-Y4	LM 20	5079	4260		ADC1	A 413.1

N 3.1 - 3.3 COPPER | alloyed <600 N/mm²

Materialnumber	Germany DIN	Europe EN	France AFNOR	Great Britain BS	Italy UNI	Sweden SIS	Spain UNE	Japan JIS	USA AISI
2.0240	CuZn 15	CW-502L	CuZn 15	CZ 102				C 2300	C 23000
2.0265	CuZn 30	CW-505L	CuZn 30	CZ 102				C 2600	C 26000
2.0321	CuZn 37	CW-508L	CuZn 37	CZ 180	C 2720				C 27200
2.0492	G-CuZn 15 Si 4	CC-761S-GS							B-198
2.0592	G-CuZn 35 Al 1	CC-765S	U-Z 36 N 3	HTB 1					C 86500
2.0966	CuAl 10 Ni 5 Fe 4	CW-307G	U-A 10 N	CA 104					C 63000
2.1006	SG-CuSn								
2.1050	G-CuSn 10	CC-480K-GS		CT 1					C 90700
2.1052	G-CuSn 12	CC-483K-GS	UE 12 P	Pb 2					C 91700
2.1060	G-CuSn 12 Ni 2	CC-484K-GS							C 91700
2.1176	G-CuPb 10 Sn	CC-495K-GS	UE 10 Pb 10	LB 2					C 93700
2.1182	G-CuPb 15 Sn	CC-496K-GS	U-Pb 15 E 8	LB 1					C 93800
2.1188	G-CuPb 20 Sn	CC-497K-GS	U-Pb 20	LB 5					C 94100
2.1266	CuCd 1								
2.1292	G-CuCrF 35	CC-140C		CC1-FF					C 81500
2.1293	CuCrZr	CW-106C	U-Cr 0.8 Zr	CC 102					C 81500

S 2.1 TITANIUM | commercially pure <600 N/mm²

Material-number	Tradename	Germany DIN	Europe EN	France AFNOR	GB BS	Italy UNI	Sweden SIS	Spain UNE	Japan JIS	USA AISI
3.7025		Ti 99,8	Titan Grade 1	AIR:9182T35	2 TA 1					R 50250
3.7035		Ti 99,7	Titan Grade 2	AIR:9182T40	2 TA 2-1					R 50400
3.7055		Ti-99,6	Titan Grade 3	AIR:9182T50	TA 3					R 50550
3.7065		Ti-99,5	Titan Grade 4	AIR:9182T60	2 TA 6-9					R 50700

S 2.2 TITANIUM | alloyed <1000 N/mm²

Material-number	Tradename	Germany DIN	Europe EN	France AFNOR	GB BS	Italy UNI	Sweden SIS	Spain UNE	Japan JIS	USA AISI
3.7105		TiNi 0,8 Mo 0,3	Titan Grade 12							
3.7115		TiAl 5 Sn 2,5	Titan Grade 6	T-A 5 E						Ti 5 Al-2,5 Sn
3.7195		TiAl 3 V 2,5	Titan Grade 9							
3.7225		Ti 1 Pd	Titan Grade 11		TP 1					R 52250
3.7235		Ti 2 Pd	Titan Grade 7							T 52400
3.7164		TiAl 6 V 4-LN	Titan Grade 5							R 56400
3.7165		TiAl 6 V4	Titan Grade 5	T-A 6 V		TA 10-13				

S 1.1 IRON-BASED ALLOY [HRSA] <1200 N/mm²

Material-number	Tradename	Germany DIN	Europe EN	France AFNOR	GB BS	Italy UNI	Sweden SIS	Spain UNE	Japan JIS	USA AISI
1.3910	Magnifer® 36	Ni36	D 1							
1.3926	Magnifer® 50	RNi12								
1.4361	X1CrNiSi1815	X 1 CrNiSi 18-15-4	X 1 CrNiSi 18 15 4							
1.4562	Nicrofer® 3127	X1NiCrMoCu32287	X 1 NiCrMoCu 32 28 7							
1.4562	Alloy 31	X1NiCrMoCu32287	X 1 NiCrMoCu 32 28 7							
1.4563	Sanicro® 28	X1NiCrMoCuN31274	X 1 NiCrMoCuN 31-27-4	X 1 NiCrMoCuN 31 27 4		X 1 NiCrMoCuN 31 27 4	2584			
1.4862	INCOLOY® Alloy DS	X12NiCr3618		Z 12 NCS 37.18	NA 17					
1.4980	INCOLOY® Alloy 286	X6NiCrTiMoVB21152	X 6 NiCrTiMoVB 21 15 2	Z 6 NCTDV 25.15 B	286 S 31					
2.4478	Alloy 52 (NiLo® 52)	FeNi 52	Titan Grade 4	AIR:9182T60	2 TA 6-9					N 14052

S 1.2 NICKEL-BASED ALLOY [HRSA] <1450 N/mm²

Material-number	Tradename	Germany DIN	Europe EN	France AFNOR	GB BS	Italy UNI	Sweden SIS	Spain UNE	Japan JIS	USA AISI
2.4602	INCONEL® 622	NiCr21Mo14W				INCONEL® 622				
2.4632	Nimonic® 90	NiCr20Co80Ti	HR 2	NC 20 KTA	NA 36	Nimonic® 90				N 07090
2.4642	INCONEL® 690	NiCr29Fe		NC 30 Fe		INCONEL® 690		NCF 690		N 06690
2.4650	Nimonic® C-263	NiCo20Cr20MoTi	HR 10	NCK 20 D	NA 38	Nimonic® C-263		NCF 690		N 07263
2.4654	Waspaloy®	NiCr19Co14Mo4Ti		NC 20 K14 Y		Waspaloy®				N 07001
2.4662	INCOLOY® 901	NiCr13Mo6Ti3		Z 8 NCDT 42						N 09901
2.4663	INCONEL® 617	NiCr23Co12Mo		NC 22 K12 D9 A		INCONEL® 617				N 06617
2.4665	Hastelloy® X	NiCr22Fe18Mo	HR 6	NC 22 FeD	NA 40	Hastelloy X				
2.4666	Nimonic® PK25	NiCr18CoMo		NKCD 20 ATU						
2.4668	INCONEL® 718	NiCr19FeNbMo	HR 8	NC 19 Fe Nb	INCONEL® 718	INCONEL® 718				N 07718
2.4669	INCONEL® X-750	NiCr15Fe7TiAl		NC 15 Fe 7 TA		INCONEL® X-750				N 07750
2.4694	INCONEL® 751	NiCr16Fe7TiAl								N 07751
2.4816	INCONEL® 600	NiCr15Fe		NC 15 Fe	NA 14	INCONEL® 600		NFC 600		N 06600
2.4819	Nimonic® C-276	NiMo16Cr15W		NC 17 D		Nimonic® C-276				N 10276
2.4851	INCONEL® 601	NiCr23Fe15		NC 23 Fe 14 A		INCONEL® 601		NCF 601		N 06601
2.4856	INCONEL® 625	NiCr22Mo9Nb		NC 22 Fe DNb	NA 21	INCONEL® 625		NCF 625		N 06625
2.4858	INCOLOY® 825	NiCr21Mo	3072.76	NC 21 Fe DU	NA 16	INCOLOY® 825		NCF 825 TB		N 08825
2.4869	Alloy 80/20	NiCr80-20								N 06003
2.4879	Centralloy® 4879	G-NiCr38W								
2.4883	Hastelloy® C276	G-NiMo16Cr								
2.4889	Nicrofer® 45 TM	NiCr28FeSiCe								N 06045
2.4951	Nicrofer® 7520	NiCr20Ti		NC 20 T	HR 5					N 06075

S 1.3 COBALT-BASED ALLOY [HRSA] <1450 N/mm²

Material-number	Tradename	Germany DIN	Europe EN	France AFNOR	GB BS	Italy UNI	Sweden SIS	Spain UNE	Japan JIS	USA AISI
2.4681	ULTIMET® alloy	CoCr26Ni9Mo5W								
2.4682	Stellite® 31	G-CoCr25NiW		KC 25 WN						ASTM A567
2.4683	Conicro® 4023 W	CoCr22NiW								
2.4691	HS 21	G-CoCr28Mo		KC 27 D5 NFe						ASTM F-75
2.4964	Stellite® 25	CoCr20W15Ni		KC 22 WN	HR 240	L605 Haynes® 25				R 30605
2.4979	S 816	CoCr28Mo6								

Technische Formeln

Schnittgeschwindigkeit
berechnen (m/min)

$$V_c = \frac{D \cdot \pi \cdot n}{1000}$$

Drehzahl
berechnen (U/min)

$$n = \frac{V_c \cdot 1000}{D \cdot \pi}$$

Vorschubgeschwindigkeit
berechnen (mm/min)

$$V_f = n \cdot z \cdot f_z$$

Zahnvorschub
berechnen (mm/Z)

$$f_z = \frac{V_f}{n \cdot z}$$

Zeitspanvolumen
berechnen (cm³/min)

$$Q = \frac{a_p \cdot a_e \cdot V_f}{1000}$$

Mittlere Spandicke
berechnen (mm)

$$h_m = f_z \cdot \frac{\sqrt{a_e}}{D}$$

Begriffserläuterung

V_c	Schnittgeschwindigkeit	in m/min
n	Drehzahl	in U/min
V_f	Vorschubgeschwindigkeit	in mm/min
F_z	Zahnvorschub	in mm/Zahn
z	Anzahl der Zähne (Schneiden)	
a_p	Zustelltiefe	in mm
a_e	Eingriffsbreite	in mm
h_m	Mittlere Spandicke	in mm
Q	Zeitspanvolumen	in cm ³ /min
D	Durchmesser Werkzeug	in mm

ERKLÄRUNG SCHNITTDATENBESTIMMUNG

BEISPIEL FÜR BESÄUMEN VON 1.2343 MIT Ø10:

P 3.2 STEEL | high alloyed <1100 N/mm²

Materialnumber	Germany DIN	Europe EN	France AFNOR	Great Britain BS	Italy UNI	Sweden SIS	Spain UNE	Japan JIS	USA AISI
1.2083	X42Cr13	X 42 Cr 13	Z 40 C 14		X 41 Cr 13 KU	2314		SUS 420 J2	420
1.2316	X36CrMo17	X 36 CrMo 17	X38CrMo 16 1		X 38 CrMo 16 1 KU		X 38 CrMo 16		D-4
1.2343	X38CrMoVH1	X 38 CrMoV 5 1	Z 38 CDV 5	BH 11	X 37 CrMoV 5 1 KU		X 37 CrMoV 5	SKD 6	H 11
1.2344	X40CrMoV51	X 40 CrMoV 5 1	Z 40 CDV 5	BH 13	X 40 CrMoV 5 1 1 KU 2242		X 40 CrMoV 5	SKD 61	H 13
1.2436	X210CrW12	X 210 CrW 12	Z 210 CW1 2		X 215 CrW 12 1 KU	2312	X 210 CrW 12	SKD 2	

DER MATERIALSCHLÜSSEL MIT DETAILLIERTEN AUFSCHLÜSSELUNGEN DER MATERIALIEN NACH MATERIALGRUPPEN BEFINDET SICH AM ENDE DES KATALOGS.

Material	Strength (N/mm ²)	Full Slot	Side Milling	Finishing	ETC	Materialgroup Factor fz / a	Materialgroup Factor ae ETC
		Vc = m/min	Vc = m/min	Vc = m/min	Vc = m/min		
P STEEL		Vc = m/min	Vc = m/min	Vc = m/min	Vc = m/min		
1.1-1.3 unalloyed	<850	200	200	220	315	1	1
2.1-2.2 low alloyed	<950	190	190	210	232	0,9	0,8
3.1-3.2 high alloyed	<1100	170	170	190	198	0,8	0,7
K CASTINGS		Vc = m/min	Vc = m/min	Vc = m/min	Vc = m/min		
1.1-1.2 grey cast iron	<1000	210	210	230	242	0,9	0,8
M STAINLESS STEEL		Vc = m/min	Vc = m/min	Vc = m/min	Vc = m/min		
1.1 ferritic/martensitic	<850	90	90	95	152	0,9	0,7
2.1 austenitic	<650	80	80	85	132	0,8	0,5
N NON-FERROUS		Vc = m/min	Vc = m/min	Vc = m/min	Vc = m/min		
1.1-2.3 ALUMINIUM alloyed/casted	<600	400	400	420	500	1,6	2
3.1-3.3 COPPER alloyed	<600	200	200	220	262	1,5	1,6
T TITANIUM		Vc = m/min	Vc = m/min	Vc = m/min	Vc = m/min		
2.1-2.2 pure/alloyed	<1000	50	50	53	75	0,8	0,5
S SUPER ALLOYS		Vc = m/min	Vc = m/min	Vc = m/min	Vc = m/min		
1.1-1.3 HRSA	<1450	25	25	28	42	0,7	0,3

ÜBERSICHT DER VERSCHIEDENEN MATERIALGRUPPEN FÜR DIESES WERKZEUG INKLUSIVE FAKTOREN

Material P 1.1-1.3

D1	L2	Immersion Angle α°	Full Slot			Side Milling			Finishing			ETC			
			fz (mm/Z)	ae = 1xD (mm)	ap = 1xD (mm)	fz (mm/Z)	ae = 0,3xD (mm)	ap (mm)	fz (mm/Z)	ae (mm)	ap (mm)	fz (mm/Z)	ae (mm)	ap (mm)	hmax (mm)
3	6	0,5°	0,015	3	3	0,02	0,9	L2max	0,013	0,2	L2max	0,045	0,8	L2max	0,0398
4	8	0,5°	0,015	4	4	0,02	1,2	L2max	0,013	0,2	L2max	0,06	1,1	L2max	0,0536
5	9	0,5°	0,025	5	5	0,03	1,5	L2max	0,02	0,2	L2max	0,07	1,3	L2max	0,0614
6	10	0,8°	0,035	6	6	0,04	1,8	L2max	0,025	0,2	L2max	0,09	1,6	L2max	0,0796
8	12	1°	0,045	8	8	0,055	2,4	L2max	0,03	0,2	L2max	0,11	1,9	L2max	0,0936
10	14	1,5°	0,05	10	10	0,065	3	L2max	0,033	0,2	L2max	0,13	2,3	L2max	0,1094
12	16	2°	0,055	12	12	0,075	3,6	L2max	0,035	0,2	L2max	0,15	2,6	L2max	0,1236
16	22	2,5°	0,065	16	16	0,085	4,8	L2max	0,04	0,2	L2max	0,17	3,3	L2max	0,1376
20	26	3°	0,08	20	20	0,1	6	L2max	0,045	0,2	L2max	0,2	3,6	L2max	0,1537

ALLE HIER ANGEGBENEN DATEN SIND FÜR DIE ERSTE GRUPPE P1.1-1.3 IN DER MATERIALGRUPPEN-ÜBERSICHT

SCHNITTDATENBESTIMMUNG:

Aus dem Materialschlüssel ergibt sich: **Materialgruppe P3.2**

Vc= 170 m/min (wie in der Tabelle angegeben)

fz= 0,065 mm/Z (wie in der Tabelle angegeben) x Faktor fz 0,8 = fz 0,052 mm/Z



ERKLÄRVIDEO

BEISPIEL FÜR ETC VON 1.4303 MIT Ø10:

M 2.1 STAINLESS STEEL | austenitic <650 N/mm²

Materialnumber	Germany DIN	Europe EN	France AFNOR	Great Britain BS	Italy UNI	Sweden SIS	Spain UNE	Japan JIS	USA AISI
1.4300	X12CrNi188					302			
1.4301	X5CrNi1810	X 6 CrNi 18 10 KD	Z 6 CN 18.09	304 S 15	X 5 CrNi 18 10	2332	X 5 CrNi 18 11	SUS 304	304 H
1.4302	X5CrNi199	X 6 CrNi 20 10 KE		308 S 96					
1.4303	X5CrNi1812	X 8 CrNi 18 12 KD	Z 8 CN 17.07	305 S 19	X 8 CrNi 19 10		X 8 CrNi 18 12	SUS 305	308
1.4305	X10CrNiS189	X 8 CrNiS 19 9	Z 8 CNF 18.09	303 S 31	X 8 CrNiS 18 9	2346	F.310.C	SUS 303	303

DER MATERIALSCHLÜSSEL MIT DETAILLIERTEN AUFSCHLÜSSELUNGEN DER MATERIALIEN NACH MATERIALGRUPPEN BEFINDET SICH AM ENDE DES KATALOGS.

Material	Strength (N/mm ²)	Full Slot	Side Milling	Finishing	ETC	Materialgroup Factor fz / a	Materialgroup Factor ae ETC
		Vc = m/min	Vc = m/min	Vc = m/min	Vc = m/min		
P STEEL		Vc = m/min	Vc = m/min	Vc = m/min	Vc = m/min		
1.1-1.3 unalloyed	<850	200	200	220	315	1	1
2.1-2.2 low alloyed	<950	190	190	210	232	0,9	0,8
3.1-3.2 high alloyed	<1100	170	170	190	198	0,8	0,7
K CASTINGS		Vc = m/min	Vc = m/min	Vc = m/min	Vc = m/min		
1.1-1.2 grey cast iron	<1000	210	210	230	242	0,9	0,8
M STAINLESS STEEL		Vc = m/min	Vc = m/min	Vc = m/min	Vc = m/min		
1.1 ferritic/martensitic	<850		90	95	152	0,9	0,7
2.1 austenitic	<650		80	85	132	0,8	0,5
N NON-FERROUS		Vc = m/min	Vc = m/min	Vc = m/min	Vc = m/min		
1.1-2.3 ALUMINIUM alloyed/casted	<600	400	400	420	500	1,6	2
3.1-3.3 COPPER alloyed	<600	200	200	220	262	1,5	1,6
T TITANIUM		Vc = m/min	Vc = m/min	Vc = m/min	Vc = m/min		
2.1-2.2 pure/alloyed	<1000		50	53	75	0,8	0,5
S SUPER ALLOYS		Vc = m/min	Vc = m/min	Vc = m/min	Vc = m/min		
1.1-1.3 HRSA	<1450		25	28	42	0,7	0,3

ÜBERSICHT DER VERSCHIEDENEN MATERIALGRUPPEN FÜR DIESES WERKZEUG INKLUSIVE FAKTOREN

Material P 1.1-1.3

D1	L2	Immersion Angle α°	Full Slot			Side Milling			Finishing			ETC			
			fz (mm/Z)	ae = 1xD (mm)	ap = 1xD (mm)	fz (mm/Z)	ae = 0,3xD (mm)	ap (mm)	fz (mm/Z)	ae (mm)	ap (mm)	fz (mm/Z)	ae (mm)	ap (mm)	hmax (mm)
3	6	0,5°	0,015	3	3	0,02	0,9	L2max	0,013	0,2	L2max	0,045	0,8	L2max	0,0398
4	8	0,5°	0,015	4	4	0,02	1,2	L2max	0,013	0,2	L2max	0,06	1,1	L2max	0,0536
5	9	0,5°	0,025	5	5	0,03	1,5	L2max	0,02	0,2	L2max	0,07	1,3	L2max	0,0614
6	10	0,8°	0,035	6	6	0,04	1,8	L2max	0,025	0,2	L2max	0,09	1,6	L2max	0,0796
8	12	1°	0,045	8	8	0,055	2,4	L2max	0,03	0,2	L2max	0,11	1,9	L2max	0,0936
10	14	1,5°	0,05	10	10	0,065	3	L2max	0,033	0,2	L2max	0,13	2,3	L2max	0,1094
12	16	2°	0,055	12	12	0,075	3,6	L2max	0,035	0,2	L2max	0,15	2,6	L2max	0,1236
16	22	2,5°	0,065	16	16	0,085	4,8	L2max	0,04	0,2	L2max	0,17	3,3	L2max	0,1376
20	26	3°	0,08	20	20	0,1	6	L2max	0,045	0,2	L2max	0,2	3,6	L2max	0,1537

ALLE HIER ANGEgebenEN DATEN SIND FÜR DIE ERSTE GRUPPE P1.1-1.3 IN DER MATERIALGRUPPEN-ÜBERSICHT

SCHNITTDATENBESTIMMUNG:

Aus dem Materialschlüssel ergibt sich: **Materialgruppe M2.1**
 Vc = 132 m/min (wie in der Tabelle angegeben)
 fz = 0,13 mm/Z (wie in der Tabelle angegeben) x Faktor fz 0,8 = **fz 0,104 mm/Z**
 ae = 2,3 mm (wie in der Tabelle angegeben) x Faktor ae 0,5 = **ae 1,15 mm ae**