

Cooling

Tolerance rs

Coating BetaUni Iron

Strategy **UNI**

Application

Features **HA**

Basic

- For universal chamfering of work pieces
- Variant made of blank form for deep cavities
- Forwards and backwards cutting

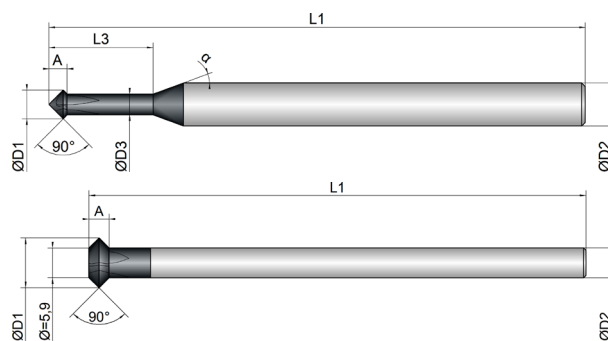

Roughing

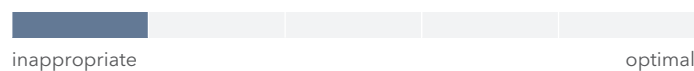

Finishing



BCU1-M10-0123	D1 mm ∅	D3 mm ∅	A mm	L3 mm	L1 mm	D2 mm ∅	z #	α °
3	3.0	2.2	2.0	10.0	75.0	4.0	4	20
3,8	3.8	2.9	2.7	13.0	75.0	4.0	4	20
4	4.0	2.9	2.7	13.0	75.0	4.0	4	20
4,8	4.8	3.9	3.0	15.0	75.0	5.0	4	20
5	5.0	3.9	3.0	15.0	75.0	5.0	4	20
5,8	5.8	3.9	4.0	15.0	100.0	6.0	4	20
6	6.0	3.9	4.0	15.0	100.0	6.0	4	20
7,8	7.8		2.0		100.0	6.0	4	0
8	8.0		2.0		100.0	6.0	4	0
9,8	9.8		4.0		100.0	6.0	4	0
10	10.0		4.0		100.0	6.0	4	0
11,8	11.8		6.0		100.0	6.0	4	0
12	12.0		6.0		100.0	6.0	4	0



Download Catalog Pages (PDF)

Dimension	Ø3	Ø3.8	Ø4	Ø4.8	Ø5	Ø5.8	Ø6	Ø7.8	Ø8	Ø9.8
Infeed in mm	ae=0.1xD ap=0.1xD	ae=0.1xD ap=0.1xD	ae=0.1xD ap=0.1xD	ae=0.1xD ap=0.1xD	ae=0.1xD ap=0.1xD	ae=0.1xD ap=0.1xD	ae=0.1xD ap=0.1xD	ae=0.1xD ap=0.1xD	ae=0.1xD ap=0.1xD	ae=0.1xD ap=0.1xD
Application										

Material	Strength (N/mm <sup>2</sup> )	Feed (mm/Z)	fz	fz	fz	fz	fz	fz	fz	fz	fz	fz	
<b>P STEEL</b>			<b>Vc (m/min)</b>										
1.1-1.3	unalloyed	<850	75	0.015	0.018	0.018	0.02	0.02	0.025	0.025	0.03	0.03	0.035
2.1-2.2	low-alloyed	<950	55	0.012	0.016	0.016	0.018	0.018	0.023	0.023	0.028	0.028	0.033
3.1-3.2	high-alloyed	<1100	40	0.01	0.014	0.014	0.015	0.015	0.02	0.02	0.025	0.025	0.03
<b>K CASTINGS</b>			<b>Vc (m/min)</b>										
1.1-1.2	grey cast iron	<1000	45	0.012	0.016	0.016	0.018	0.018	0.023	0.023	0.028	0.028	0.033
<b>M STAINLESS STEEL</b>			<b>Vc (m/min)</b>										
1.1	ferritic/martensitic	<850	35	0.01	0.014	0.014	0.016	0.016	0.02	0.02	0.024	0.024	0.028
2.1	austenitic	<650	30	0.008	0.012	0.012	0.014	0.014	0.018	0.018	0.022	0.022	0.026
<b>N NON-FERROUS</b>			<b>Vc (m/min)</b>										
1.1-2.3	ALUMINIUM   alloyed/cast	<600	150	0.02	0.023	0.023	0.025	0.025	0.03	0.03	0.035	0.035	0.04
3.1-3.3	COPPER   alloyed	<600	80	0.012	0.014	0.014	0.015	0.015	0.02	0.02	0.025	0.025	0.03
<b>T TITANIUM</b>			<b>Vc (m/min)</b>										
2.1-2.2	pure/alloyed	<1000	30	0.008	0.012	0.012	0.014	0.014	0.018	0.018	0.022	0.022	0.026
<b>S SUPER ALLOYS</b>			<b>Vc (m/min)</b>										
1.1-1.3	HRSA	<1450	20	0.007	0.01	0.01	0.012	0.012	0.016	0.016	0.02	0.02	0.024

Dimension	Ø10	Ø11.8	Ø12
Infeed in mm	ae=0.1xD ap=0.1xD	ae=0.1xD ap=0.1xD	ae=0.1xD ap=0.1xD
Application			

Material	Strength (N/mm <sup>2</sup> )	Feed (mm/Z)	fz	fz	fz	
<b>P STEEL</b>			<b>Vc (m/min)</b>			
1.1-1.3	unalloyed	<850	75	0.035	0.04	0.04
2.1-2.2	low-alloyed	<950	55	0.033	0.038	0.038
3.1-3.2	high-alloyed	<1100	40	0.03	0.035	0.035
<b>K CASTINGS</b>			<b>Vc (m/min)</b>			
1.1-1.2	grey cast iron	<1000	45	0.033	0.038	0.038
<b>M STAINLESS STEEL</b>			<b>Vc (m/min)</b>			
1.1	ferritic/martensitic	<850	35	0.028	0.034	0.034
2.1	austenitic	<650	30	0.026	0.032	0.032
<b>N NON-FERROUS</b>			<b>Vc (m/min)</b>			
1.1-2.3	ALUMINIUM   alloyed/cast	<600	150	0.04	0.045	0.045
3.1-3.3	COPPER   alloyed	<600	80	0.03	0.035	0.035
<b>T TITANIUM</b>			<b>Vc (m/min)</b>			
2.1-2.2	pure/alloyed	<1000	30	0.026	0.032	0.032
<b>S SUPER ALLOYS</b>			<b>Vc (m/min)</b>			
1.1-1.3	HRSA	<1450	20	0.024	0.03	0.03

**ADVICE** | The values marked in turquoise are side applications!

# EXPLANATION

































## APPLICATIONS

 Multipass milling	 Trimming	 Deburring	 Engraving
 Corner rounding	 Full slot milling	 Forward and backward deburring	 Infeed Z





## COOLINGS

 Air-cooling	 Dry machining	 Oil cooling	 Cooling Lubricant
 Minimum quantity lubrication			

## FEATURES







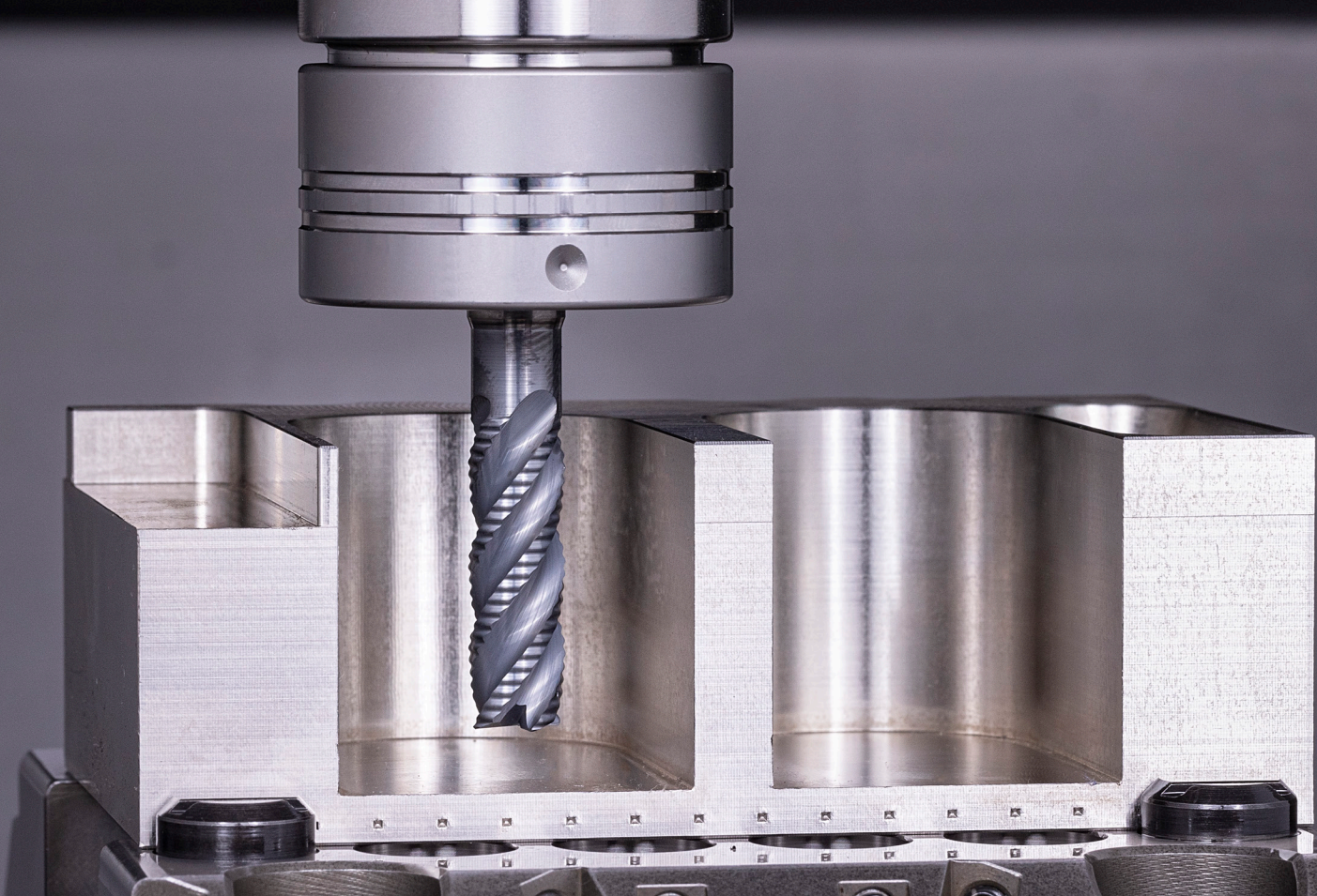









 0,5xD	 1xD	 1,5xD	 2xD
 2,5xD	 3xD	 3,5xD	 4xD
 5xD	 8xD	 Center cutting	 Non-center cutting
 Without Weldon	 With Weldon	 With Notch surface	 Internal cooling
 Twisted internal cooling	 Dynamic helical pitch	 Chip breaker	 Unequal tooth pitch
 Roughing teeth	 Helical immersion	 Feed directions x,y	 Feed directions x, y, z
 Feed directions x, y, (z)	 Feed direction z	 Corner radius	 Corner bevel
 Sharp edged	 60° Tip	 90° Tip	 140° Tip

## STRATEGY

 Extended Trochoidal Cutting	 High Performance Cutting	 High Speed Cutting	 Multi Task Cutting
 Universal Machining			



## PROPERTIES

 Cutting diameter	 Small cutting diameter	 Large cutting diameter	 Undercut diameter
 Cutting length	 Total bevel length	 Undercut length	 Total length
 Shank diameter	 Number of teeth	 Corner radius	 Corner bevel
 Programming radius	 Maximum cutting depth	 Helical angle	 Alpha angle
 Recess and cut length			

## APPLICATION TABLE

The values given in the application table are only guidelines. These values are largely dependent on the machining situation and application.

## FIGURES

All technical drawings and photographs are given as an example. The product may deviate from the original in terms of colour and dimensions.

**P 1.1 STEEL | unalloyed <500 N/mm<sup>2</sup>**

Materialnumber	Germany   DIN	Europe   EN	France   AFNOR	Great Britain   BS	Italy   UNI	Sweden   SIS	Spain   UNE	Japan   JIS	USA   AISI
1.0254	St37.0	P235T1						STPG 38	
1.1120	GS20Mn5							SMnC 420	
1.1121	Ck10	2 C.10	XC 10	040 A 10	C 10	1265	C 10 k	S 10 C	1010
1.1131	GS15Mn5								
1.8961	WTS1373				Fe 360 D FF			SMA 50 A	
1.0715	9SMn28	11 SMn 28	S 250	230 M 07	CF 9 SMn 28	1912	11 SMn 28	SUM 22	1213
1.0718	9SMnPb28	11 SMnPb28	S 250 Pb		CF 9SMnPb 28	1914	11 SMnPb 28	SUM 22 L	12 L 13
1.0736	9SMn36		S300	240 M 07	CF 9 SMn 36		12 SMn 35	SUM 25	1215

**P 1.2 STEEL | unalloyed <700 N/mm<sup>2</sup>**

Materialnumber	Germany   DIN	Europe   EN	France   AFNOR	Great Britain   BS	Italy   UNI	Sweden   SIS	Spain   UNE	Japan   JIS	USA   AISI
1.0116	ST373		E 24-3	4360-40 C	Fe 37-3	1312	A 360 C		A 570 Gr. 36
1.0144	ST443		E 28-3	4360-43 C	Fe 430 D FF	1414	AE 275-D	SM 41 B	A 573 Gr. 70
1.0401	C15		CC12	080 M 15	C 15	1350	F.111	S 15 C	1015
1.0402	C22	1 C.22	CC 22	070 M 20	C 22		C 22 k	SFVC 1	
1.0406	C25	1 C.25	CC 25	070 M 26	C 25		C 25 k	S 22 C	1025
1.0482	19Mn5		A 52 CP	224-460				SG 37	
1.0486	STE285				FE E 285 KG		AE 285 KG	SM 41 A	
1.0501	C35	1 C.35	CC 35	060 A 35	C 35	1550	F.113	S 35 C	1035
1.0503	C45	1 C.45	CC 45	080 M 46	C 45	1650	C 45 k	S 45 C	1045
1.0528	C30	1 C.30	CC 32	080 M 30	C30			SUP 7	1030
1.0562	STE355		E 355 R/FP		Fe E 355 KG	2132	AE 355 KG	SM 50 YB	A 633 Gr. C
1.0711	9S20			220 M 07	CF 9 S 22			G 11120	1212
1.1127	36Mn6			212 M 36				SMn 443	1141
1.1133	20Mn5			120 M 19	G 22 Mn3		20 Mn 6	SMn 420	1022
1.5637	10Ni14			503	18 Ni 14 KT				A 350-LF 5
1.8962	9CrNiCuP324			WR 50 A				SPA-H	
1.0726	35S20	35 S 20	35 MF 4	212 M 36		1957	F.210G		1140
1.0760	38SMn28	38SMn28	38SMn28	38SMn28			38SMn28		
1.5423	16Mo5			1503-245-420	16 Mo 5		16 Mo 5	SBC 690	4520

**P 1.3 STEEL | unalloyed <850 N/mm<sup>2</sup>**

Materialnumber	Germany   DIN	Europe   EN	France   AFNOR	Great Britain   BS	Italy   UNI	Sweden   SIS	Spain   UNE	Japan   JIS	USA   AISI
1.1525	C80W1	C 80 U	Y1 90		C 80 KU	1880	F.513		W 108
1.1545	C105W1	C 105 U	Y1 105	BW 1A	C 100 KU	1880	F.515		W 110
1.1620	C70W2	C 70 U							
1.1625	C80W2		Y1 80	BW 1B	C 80 KU		C 80	SKC 3	W 1
1.1645	C105W2						C 102	SK 3	
1.1663	C125W	C 120 U	Y2 120		C 120 KU		C 120	SK 2	W 112
1.1673	C135W		Y2 140		C 140 KU			SK 1	
1.1740	C60W		Y3 55					SK 7	
1.1830	C85W	C 90 U	Y3 90					SK 5	1084
1.1744	C67W		Y1 70				F.512		A-6
1.5406	17MoV84								
1.5633	24Ni8	G 9 Ni 10	22 N 8		G 9 Ni 10			SCPL 21	
1.6311	20MnMoNi45	20 MnMoNi 4 5						SQV 2 B	
1.7242	16CrMo4	18 CrMo 4	15 CD 3.5		18 CrMo 4		18 CrMo 4	SCM 418 H	
1.7350	22CrMo44								
1.7362	12CrMo195	X 12 CrMo 5	Z 10 CD 5.05	3606-625	16 CrMo 20 5			SCMV 6	
1.7709	21CrMoV57	21 CrMoV 5 7	20 CDV 5.07						

### P 2.1 STEEL | low alloyed <750 N/mm<sup>2</sup>

Materialnumber	Germany   DIN	Europe   EN	France   AFNOR	Great Britain   BS	Italy   UNI	Sweden   SIS	Spain   UNE	Japan   JIS	USA   AISI
1.0961	60SiCr7	60 SiCr 8	60 SC 7	250 A 61	60 SiCr 8		60 SiCr 8	SUP 7	9262
1.2162	21MnCr5	21 MnCr 5	20 NC 5					SCR 420 H	
1.2210	115CrV3	107 CrV 3 KU	100 C 3		107 CrV 3 KU		F.520.L		L2
1.2235	80CrV2						F.520.J		
1.2241	51CrV4	51 CRMnV 4			51 CrMnV 4 KU				S6
1.2382	GX155CrVMo121								
1.2542	45WCrV7	45 WCrV 8		BS 1	45 WCrV 8 KU	2710	45 WCrSi 8		S1
1.2552	80WCrV8						60 WCrSi 8		
1.2842	90MnCrV8	90 MnV 8	90 MV 8	BO 2	90 MnVCr 8 KU				0 2
1.7003	38Cr2	38 Cr 2 KD	38 C 2	120 M 36	38 Cr 3		38 Cr 3	SMn 438	50 B40
1.7131	16MnCr5	16 MnCr 5 KD	16 MC 5	527 M 17	16 MnCr 5	2173	16 MnCr 5	SCR 415	5115
1.7715	14MoV63	14 MoV 6-3		1503-660-440			13 MoCrV 6		

### P 2.2 STEEL | low alloyed <950 N/mm<sup>2</sup>

Materialnumber	Germany   DIN	Europe   EN	France   AFNOR	Great Britain   BS	Italy   UNI	Sweden   SIS	Spain   UNE	Japan   JIS	USA   AISI
1.0902	46Si7		45 S7				46 Si 7		
1.1157	40Mn4		35 M 5	150 M 36					1039
1.1167	36Mn5		40 M 5	150 M 36		2120	36 Mn 5		1335
1.1170	28Mn6	28 Mn 6	35 M 5	150 M 17	C 28 Mn		36 Mn 6	SCMn 1	1330
1.1199	49MnVS3			280 M 01					
1.2002	125Cr1		Y2 120 C						
1.2003	75Cr1		35 M 5	150 M 36					
1.2004	85Cr1		Y1 100 C 2						
1.2008	140Cr3		Y2 140 C					SKS 8	
1.2108	90CrSi5	P 280 GH			C 100 KU	2092		SFVC 2A	
1.2127	105MnCr4				100 CrMn 4 KU			SUJ 3	
1.2303	100CrMo5						F.520.F		L 7
1.2312	40CrMnMoS86		40 CMD 8						
1.2519	110WCrV5						102 WCrV 5		
1.3501	100Cr2		100 C 2						E 50100
1.3505	100Cr6	100 Cr 6	100 C 6	535 A 99	100 Cr 6	2258	100 Cr 6	SUJ 2	E52100
1.3520	100CrMn6	100 Cr Mn 6	100 CM 6				100 CrMn 6		

### P 3.1 STEEL | high alloyed <800 N/mm<sup>2</sup>

Materialnumber	Germany   DIN	Europe   EN	France   AFNOR	Great Britain   BS	Italy   UNI	Sweden   SIS	Spain   UNE	Japan   JIS	USA   AISI
1.2363	X100CrMoV51	X 100 CrMoV 5 1	Z 100 CDV 5	BA 2	X 100 CrMoV 5 1 KU	2260	X 100 CrMoV 5	SKD 12	A 2
1.2367	X38CrMoV53		Z 38 CDV 5 3						
1.2379	X155CrVMo121	X 153 CrMoV 12	Z 160 CDV 12	BD 2	X 155 CrVMo 12 1 KU	2310		SKD 11	D 2
1.2453	X130W5								
1.2564	X30WCrV41	30 WCrV 15 1					F.527		
1.2567	X30WCrV53	X 30 WCrV 5 3	Z 32 WCV 5		X 30 WCrV 5 3 KU			SKD 4	
1.2606	X37CrMoW51		Z 35 CWDV 5	BH 12	X 35 CrMoW 05 KU		F.537	SKD 62	H 12

**P 3.2 STEEL | high alloyed <1100 N/mm<sup>2</sup>**

Materialnumber	Germany   DIN	Europe   EN	France   AFNOR	Great Britain   BS	Italy   UNI	Sweden   SIS	Spain   UNE	Japan   JIS	USA   AISI
1.2083	X42Cr13	X 42 Cr 13	Z 40 C 14		X 41 Cr 13 KU	2314		SUS 420 J2	420
1.2316	X36CrMo17	X 36 CrMo 17	X38CrMo 16 1		X 38 CrMo 16 1 KU		X 38 CrMo 16		D-4
1.2343	X38CrMoVH1	X 38 CrMoV 5 1	Z 38 CDV 5	BH 11	X 37 CrMoV 5 1 KU		X 37 CrMoV 5	SKD 6	H 11
1.2344	X40CrMoV51	X 40 CrMoV 5 1	Z 40 CDV 5	BH 13	X 40 CrMoV 5 1 1 KU 2242		X 40 CrMoV 5	SKD 61	H 13
1.2436	X210CrW12	X 210 CrW 12	Z 210 CW1 2		X 215 CrW 12 1 KU 2312		X 210 CrW 12	SKD 2	
1.2581	X30WCrV93	X 30 WCrV 9 3	Z 30 WCV 9	BH 21	X 30 WCrV 9 3 KU		X 30 WCrV 9	SKD 5	H 21
1.2601	X165CrMoV12	X 165 CrMoV 12			X 165 CrMoV 12 KU 2310		X 160 CrMoV 12		
1.2767	X45NiCrMo4	40 NiCrMo 4	Y 35 NCD 16		42 NiCrMo 15 7 KU				A 9
1.2779	X6NiCrTi2615			S 66286					660
1.3302	S1214	HS 12 1 4			X 150 WV 1305 KU				A 7
1.3318	S1212	HS 02.01.12							
1.3401	X120Mn12	X 120 Mn 12	Z 120 M 12	BW 10	X G 120 Mn 12	2183	AM-X 120 Mn 12	SCMnH 1	A 128
1.3543	X102CrMo17	X 102 CrMo 17	X100CrMo17		X 105 CrMo 17		X 100 CrMo 17		
1.3549	X89CrMoV81								
1.3551	80MoCrV4216		80 DCV 40	T 11350	X 80 MoCrV 4 4		80 MoCrV 40-16		M 50
1.7225	42CrMo4.M45	42 CrMo 4	42 CD 4	708 A 42	42 CrMo 4	2244		SCM 440 H	4140

**K 1.1 GREY CAST IRON <600 N/mm<sup>2</sup> (180 HB)**

Materialnumber	Germany   DIN	Europe   EN	France   AFNOR	Great Britain   BS	Italy   UNI	Sweden   SIS	Spain   UNE	Japan   JIS	USA   AISI
0.6010	GG10	GJL-100	FGL 100	Grade 100	G 10	0110-00	FG 10	FC 100	A48-20 B
0.6012	GG150 HB	GJL-HB 170							
0.6015	GG15	GJL-150	FGL 150	Grade 150	G 15	0115-00	FG 15	FC 150	A48-25 B
0.6017	GG170 HB	GJL-HB 205							

**K 1.2 GREY CAST IRON <1000 N/mm<sup>2</sup> (300 HB)**

Materialnumber	Germany   DIN	Europe   EN	France   AFNOR	Great Britain   BS	Italy   UNI	Sweden   SIS	Spain   UNE	Japan   JIS	USA   AISI
0.6020	GG20	GJL-200	FGL 200	Grade 220	G 20	0120-00	FG 20	FC 200	A48-30 B
0.6022	GG190 HB	GJL-HB 230							
0.6025	GG25	GJL-250	FGL 250	Grade 260	G 25	0125-00	FG 25	FC 250	A48-40 B
0.6027	GG220 HB	GJL-HB 250	FGL 250						
0.6030	GG30	GJL-300	FGL 300	Grade 300	G 30	0130-00	FG 30	FC 300	A48-45 B
0.6032	GG240 HB	GJL-HB 275							
0.6035	GG35	GJL-350	FGL 350	Grade 350	G 35	0135-00	FG 35	FC 350	A48-50 B
0.6037	GG260 HB	GJL-HB 275							
0.6040	GG40	GJL-400	FGL 400	Grade 400		0140-00			A48-60 B

**M 1.1 STAINLESS STEEL FERRITIC/MARTENSITIC <850 N/mm<sup>2</sup>**

Materialnumber	Germany   DIN	Europe   EN	France   AFNOR	Great Britain   BS	Italy   UNI	Sweden   SIS	Spain   UNE	Japan   JIS	USA   AISI
1.4000	X6Cr13	X 6 Cr 13	Z 6 C 13	403 S 17	X 6 Cr 13	2301	X 6 Cr 13	SUS 403	403
1.4002	X6CrAl13	X 6 CrAl 13	Z 6 CA 13	405 S 17	X 6 CrAl 13	2302	X 6 CrAl 13	SUS 405	405
1.4005	X12CrS13	X 12 CrS 13	Z 12 CF 13	416 S 21	X 12 CrS 13	2380	X12 CrS 13	SUS 416	416
1.4006	X10Cr13	X 12 Cr 13 KD	Z 12 C 13	410 S 21	X 12 Cr 13	2302	X 12 Cr 13	SUS 410	410
1.4008	GX8CrNi13	GX 7 CrNiMo 12 1	Z 12 CN 13 M	410 C 21	GX 12 Cr 13			SCS 1	414
1.4016	X6Cr17	X 8 Cr 17	Z 8 C 17	430 S 15	X 8 Cr 17 KD	2320	X 8 Cr 17	SUS 430	430
1.4021	X20Cr13	X 20 Cr 13	Z 20 C 13	420 S 37	X 20 Cr 13	2303	X 20 Cr 13	SUS 420 J1	420
1.4024	X15Cr13	X 15 Cr 13	Z 12 C 13 M	420 S 29	X 12 Cr 13			SUS 410 J1	
1.4027	GX20Cr14		Z 20 C 13 M	420 C 29				SCS 2	
1.4028	X30Cr13	X 30 Cr 13	Z 30 Cr 13	420 S 45	X 30 Cr 13	2304	X 30 Cr 13	SUS 420 J2	420
1.4034	X45Cr13	X 45 Cr 13	Z 40 C 14	420 S 45	X 40 Cr 14		X 46 Cr 13		420
1.4057	X19CrNi172	X 19 CrNi 17 2	Z 15 CN 16.02	431 S 29	X 16 CrNi 16	2321	X 15 CrNi 16	SUS 431	431
1.4104	X12CrMoS17	X 14 CrMoS 17	Z 10 CF 17	441 S 29	X 10 CrS 17	2383	X 10 CrS 17	SUS 430 F	430 F
1.4105	X4CrMoS18	X 6 CRMoS 17	Z 6 CDF 18-02					SUS 430 F	430
1.4107	GX8CrNi12	GX 8 CrNi 12	GX 8 CrNi 12		GX 8 CrNi 12				
1.4109	X65CrMo14	X 70 CrMo 15	Z 70 CD 14					SUS 440 A	440 A
1.4110	X55CrMo14		Z 50 CD 13						
1.4112	X90CrMoV18	X 90 CrMoV 18	Z 3 CT 1 2	409 S 1 9	X 6 Cr Ti 1 2			SUS 440 B	440 B
1.4113	X6CrMo171	X 8 CrMo 17	Z 8 CD 17.02	434 S 17	X 8 CrMo 17	2325		SUS 434	434
1.4116	X45CrMoV15	X 50 CrMoV 15	Z 50 CD 15		X50 CrMoV 15		X 46 CrMo 16		
1.4122	X35CrMo17	X 39 CrMo 17 1	X39CrMo17-1		X 35 CrMo 17				
1.4125	X105CrMo17	X 105 CrMo 17	Z 100 CD 17		X 105 CrMo 17			SUS 440 C	440 C
1.4136	GX70CrMo292		Z 60 CD 29.2 M						
1.4313	X5CrNi134	X 3 CrNiMo 13 4	Z 4 CDN 13.4	425 C 11	X 3 CrNiMo 13 4	2385		SCS 5	CA 6-NM
1.4317	GX4CrNi134	GX 4 CrNi 13 4	GX 4 CrNi 13 4		GX 4 CrNi 13 4				
1.4351	X3CrNi134	X 3 CrNi 14 04 KE							
1.4405	GX5CrNiMo165	GX 4 CrNiMo 16 5 1	GX 4 CrNiMo 16 5 1		GX 4 CrNiMo 16 5 1				
1.4510	X6CrTi17	X 8 CrTi 17	Z 8 CT 17		X 6 CrTi 17		X 8 CrTi 17	SUS 430 LX	430 Ti
1.4511	X6CrNb17	X 3 CrNb 17	Z 8 CNb 17		X 6 CrNb 17			SUS 430 LX	430 Nb
1.4512	X6CrTi12	X 5 CrTi 12	Z 6 CT 12	409 S 19	X 6 CrTi12			SUH 409	409
1.4523	X8CrMoTi17	X 2 CrMoTiS 18 2	X 2 CrMoTiS 18 2						
1.4704	X45SiCr4	45SiCr16-11							HNV 2
1.4718	X45CrSi93	X 45 CrSi 8	Z 45 CS 9	401 S 45	X 45 CrSi 8		F.3220	SUH 1	HNV 3
1.4722	X10CrSi13						X 10 CrSi 13		
1.4724	X10CrAl13	X 10 CrAl 13	Z 10 C 13	BH 12	X 10 CrAl 12		X 10 CrAl 13	SUS 405	H-12
1.4725	X8CrAl144	CrAl 14 4	K 91670						
1.4747	X80CrNiSi20	X 80 CrNiSi 20	Z 80 CSN 20.02	433 S 65	X 80 CrSiNi 20		X 80 CrSiNi20-02	SUH 4	HNV 6
1.4762	X10CrAl24	X 10 CrAl 24	Z 10 CAS 24		X 16 Cr 26	2322	X 10 CrAl 24	SUH 442	446
1.4767	X8CrAl205	CrAl 20 5							

**M 2.1 STAINLESS STEEL | austenitic <650 N/mm<sup>2</sup>**

Materialnumber	Germany   DIN	Europe   EN	France   AFNOR	Great Britain   BS	Italy   UNI	Sweden   SIS	Spain   UNE	Japan   JIS	USA   AISI
1.4300	X12CrNi188			302					
1.4301	X5CrNi1810	X 6 CrNi 18 10 KD	Z 6 CN 18.09	304 S 15	X 5 CrNi 18 10	2332	X 5 CrNi 18 11	SUS 304	304 H
1.4302	X5CrNi199	X 6 CrNi 20 10 KE		308 S 96					
1.4303	X5CrNi1812	X 8 CrNi 18 12 KD	Z 8 CN 17.07	305 S 19	X 8 CrNi 19 10		X 8 CrNi 18 12	SUS 305	308
1.4305	X10CrNiS189	X 8 CrNiS 19 9	Z 8 CNF 18.09	303 S 31	X 8 CrNiS 18 9	2346	F.310.C	SUS 303	303
1.4307	X2CrNi189	X 2 CrNi 18 9	CLC 18.9.L	304 S 11	X 2 CrNi 18 9			SUS 304 L	304 L
1.4308	GX6CrNi189	X 2 CrNi 18 7	Z 6 CN 18.10 M	304 C 15	GX 5 CrNi 19 10	2333		SCS 13	CF-8
1.4310	X12CrNi177	X 12 CrNi 17 7	Z 12 CN 17.07	301 S 21	X 12 CrNi 17 07		X 12 CrNi 17 07	SUS 301	301
1.4311	X2CrNiN1810	X 2 CrNiN 18 10	Z 8 CN 18.12	304 S 62	X 8 CrNi 19 10	2371	X 8 CrNi 18 12	SUS 304 LN	304 LN
1.4312	GX10CrNi188		Z 10 CN 18.9 M	302 C 25				SCS 12	
1.4318	X 2 CrNiN 18 7	X 2 CrNiN 18 7	18-7L		18-7L				
1.4319	X3CrNiN178			302 S 26	X 10 CrNi 18 09			SUS 302	
1.4350	X5CrNi189		Z 6 CN 18.09	304 S 31	X 5 CrNi 18 10				304
1.4401	X5CrNiMo17122	X 6 CrNiMo 17 12 2 KD	Z 6 CND 17.11	316 S 16	X 5 CrNiMo 17 12	2347	X 5 CrNiMo 17 12	SUS 316	316
1.4404	X2CrNiMo17132	GX 3 CrNiMo 17 12 2 KD	Z 3 CND 19.10 M	316 S 12	GX 2 CrNiMo 19 11	2348	X 2 CrNiMo	SUS 316 L	316 L
1.4406	X2CrNiMoN17122	X 3 CrNiMoN 17 12 2	Z 2 CND 17.12 Az	316 S 61	X 2 CrNiMoN 17 12			SUS 316 LN	316 LN
1.4407	GX 5 CrNiMo 13 4	GX 5 CrNiMo 13 4	J 91550						A757
1.4408	GX6CrNiMo1810	GX 5 CrNiMo 19 11 2	GX 5 CrNiMo 19 11 2	316 C 16	GX 5 CrNiMo 19 11 2	2343	X 7 CrNiMo 20 10	SCS 14	CF-8M
1.4435	X2CrNiMo18143	X 2 CrNiMo 18 16	Z 2 CDN 17.13	316 S 11	X 2 CrNiMo 17 13	2353		SVS 16	316 L
1.4436	X5CrNiMo17133	X 6 CrNiMo 18 13 3 KD	Z 6 CND 17.12	316 S 16	X 5 CrNiMo 17 13	2343	X 6 CrNiMo 17 12 03	SUS 316	316
1.4438	X2CrNiMo18164	X 3 CrNiMo 18 16 4	Z 2 CND 19.15	317 S 12	X 2 CrNiMo 18 15	2367		SUS 317 L	317 L
1.4440	X2CrNiMo18165								
1.4442	X2CrNiMo18154		X 3 CrNiMoN 18 14						



## N 1.1 ALUMINIUM | alloyed <500 N/mm<sup>2</sup>

Materialnumber	Germany   DIN	Europe   EN	France   AFNOR	Great Britain   BS	Italy   UNI	Sweden   SIS	Spain   UNE	Japan   JIS	USA   AISI
3.1255	AlCu 4 SiMg	AW-2014	A-U4SG	H 15	P-AlCu 4.4 SiMnMg		L-3130	A2014	AA2014
3.1305	AlCu 2.5 Mg	AW-2117	A-U2G	L 86	P-AlCu 2.5 MgSi		L-3180	A2117	AA2117
3.1324	AlCu 4 MgSi	AW-2017 A							
3.1325	AlCuMg1	AW-2017 A	A-U4G	H 14	P-AlCu 4.5 MgMn	GA631	L-3120	A2017	AA2017 A
3.1355	AlCuMg2	AW-2024	A-U4G1	L 97 / L 98	P-AlCu 4.5 MgMn	5	L-3140	A2024	AA2024
3.2315	AlMgSi 1	AW-6082	A-SGM0,7	H 30	P-AlMgSi	4212	L-3453		AA6082
3.3206	AlMgSi 0.5	AW-6060	A-GS	H 9	P-AlMgSi	4140	L-3442		AA6060
3.3208	Al99.9 MgSi	AW-6401							
3.3210	AlMgSi 0.7	AW-6005 A							
3.3211	AlMg 1 SiCu	AW-6061	A-GSUC	H 20	P-AlMg 1 SiCu		L-3420	A6061	AA6061
3.3315	AlMg1	AW-5005 A	A-G0,6	N 41	P-AlMg 0.9	4106	L-3350	A5005	AA5005 A
3.3316	AlMg 1.5	AW-5050	A-G1,5	3L 44	P-AlMg 1.5		L-3380		AA5050 B
3.3317	Al99.85 Mg 1	AW-5305							
3.3318	Al99.9 Mg 1	AW-5505							
3.3326	AlMg 1.8	AW-5051 A							
3.3345	AlMg 4.5	AW-5082	A-G4,5		P-AlMg 4.4			A5082	AA5082
3.3523	AlMg 2.5	AW-5052	A-G2,5C	L 80 / L 81	P-AlMg 2.5	4120	L-3360	A5052	AA5052
3.3525	AlMg 2 Mn 0.3	AW-5251	A-G2M	N4	P-AlMg 2 Mn		L-3361		AA5251
3.3527	AlMg 2 Mn 0.8	AW-5049	A-G2,5MC					A5049	AA5049
3.3535	AlMg 3	AW-5754	A-G3M		P-AlMg 3.5	4130	L-3390		AA5754
3.3537	AlMg 2.7 Mn	AW-5454	A-G2,5MC		P-AlMg 2.7 Mn	4130	L-3391		AA5454
3.3541	G-AlMg 3	AC-51100							
3.3545	AlMg 4 Mn	AW-5086	A-G4MC		P-AlMg 4.4		L-3382		AA5086
3.3547	AlMg 4 Mn	AW-5086	A-G4MC	N8	P-AlMg 4.5	4140	L-3321	A5083	AA5083

## N 1.2 ALUMINIUM | alloyed <600 N/mm<sup>2</sup>

Materialnumber	Germany   DIN	Europe   EN	France   AFNOR	Great Britain   BS	Italy   UNI	Sweden   SIS	Spain   UNE	Japan   JIS	USA   AISI
3.0615	AlMgSiPb	AW-6012	A-SGPb		P-AlSiMgMn		L-3452		AA6012
3.1645	AlCu 4 PbMgMn	AW-2007				4355	L-3121	A2007	AA2007
3.1655	AlCu 6 BiPb	AW-2011	A-U5PbBi	FC 1	P-AlCu 5.5 PbBi	4338	L-3192	A2011	AA2011
3.4335	AlZn 4.5 Mg 1	AW-7020	A-Z5G	H 17		4425	L-3741		AA7020
3.4345	AlZnMgCu 0.5	AW-7022	A-Z4GU						AA7022
3.4365	AlZnMgCu 1.5	AW-7075	A-Z5GU	2L 95	P-AlZn 5.8 MgCu		L-3710	A7075	AA7075

## N 2.1 - 2.3 ALUMINIUM | cast <600 N/mm<sup>2</sup>

Materialnumber	Germany   DIN	Europe   EN	France   AFNOR	Great Britain   BS	Italy   UNI	Sweden   SIS	Spain   UNE	Japan   JIS	USA   AISI
3.2151	G-AlSi 6 Cu 4	AC-45000	A-S5UZ	LM 4				AC4B	A 319.0
3.2161	G-AlSi 8 Cu 3	AC-46200	A-S9U3A-Y4	LM 24	5075			AC4D	A 328.0
3.2371	G-AlSi 7 Mg 0,3	AC-42100						AC4CH	A 356.0
3.2373	G-AlSi 9 Mg	AC-43300							
3.2381	G-AlSi 10 Mg	AC-43100							
3.2383	G-AlSi 10 Mg(Cu)	AC-43400	A-S10G	LM 9	3049	4253		ADC3	A 360.2
3.2581	G-AlSi 12	AC-47100	A-S13	LM 6	4514	4261		AC3A	A 413.2
3.2583	G-AlSi 12 Cu	AC-44300	A-S12-Y4	LM 20	5079	4260		ADC1	A 413.1

### N 3.1 - 3.3 COPPER | alloyed <600 N/mm<sup>2</sup>

Materialnumber	Germany   DIN	Europe   EN	France   AFNOR	Great Britain   BS	Italy   UNI	Sweden   SIS	Spain   UNE	Japan   JIS	USA   AISI
2.0240	CuZn 15	CW-502L	CuZn 15	CZ 102				C 2300	C 23000
2.0265	CuZn 30	CW-505L	CuZn 30	CZ 102				C 2600	C 26000
2.0321	CuZn 37	CW-508L	CuZn 37	CZ 180	C 2720				C 27200
2.0492	G-CuZn 15 Si 4	CC-761S-GS							B-198
2.0592	G-CuZn 35 Al 1	CC-765S	U-Z 36 N 3	HTB 1					C 86500
2.0966	CuAl 10 Ni 5 Fe 4	CW-307G	U-A 10 N	CA 104					C 63000
2.1006	SG-CuSn								
2.1050	G-CuSn 10	CC-480K-GS		CT 1					C 90700
2.1052	G-CuSn 12	CC-483K-GS	UE 12 P	Pb 2					C 91700
2.1060	G-CuSn 12 Ni 2	CC-484K-GS							C 91700
2.1176	G-CuPb 10 Sn	CC-495K-GS	UE 10 Pb 10	LB 2					C 93700
2.1182	G-CuPb 15 Sn	CC-496K-GS	U-Pb 15 E 8	LB 1					C 93800
2.1188	G-CuPb 20 Sn	CC-497K-GS	U-Pb 20	LB 5					C 94100
2.1266	CuCd 1								
2.1292	G-CuCrF 35	CC-140C		CC1-FF					C 81500
2.1293	CuCrZr	CW-106C	U-Cr 0.8 Zr	CC 102					C 81500

### S 2.1 TITANIUM | commercially pure <600 N/mm<sup>2</sup>

Material-number	Tradename	Germany   DIN	Europe   EN	France   AFNOR	GB   BS	Italy   UNI	Sweden   SIS	Spain   UNE	Japan   JIS	USA   AISI
3.7025		Ti 99,8	Titan Grade 1	AIR:9182T35	2 TA 1					R 50250
3.7035		Ti 99,7	Titan Grade 2	AIR:9182T40	2 TA 2-1					R 50400
3.7055		Ti-99,6	Titan Grade 3	AIR:9182T50	TA 3					R 50550
3.7065		Ti-99,5	Titan Grade 4	AIR:9182T60	2 TA 6-9					R 50700

### S 2.2 TITANIUM | alloyed <1000 N/mm<sup>2</sup>

Material-number	Tradename	Germany   DIN	Europe   EN	France   AFNOR	GB   BS	Italy   UNI	Sweden   SIS	Spain   UNE	Japan   JIS	USA   AISI
3.7105		TiNi 0,8 Mo 0,3	Titan Grade 12							
3.7115		TiAl 5 Sn 2,5	Titan Grade 6	T-A 5 E						Ti 5 Al-2,5 Sn
3.7195		TiAl 3 V 2,5	Titan Grade 9							
3.7225		Ti 1 Pd	Titan Grade 11		TP 1					R 52250
3.7235		Ti 2 Pd	Titan Grade 7							T 52400
3.7164		TiAl 6 V 4-LN	Titan Grade 5							R 56400
3.7165		TiAl 6 V4	Titan Grade 5	T-A 6 V	TA 10-13					

### S 1.1 IRON-BASED ALLOY [HRSA] <1200 N/mm<sup>2</sup>

Material-number	Tradename	Germany   DIN	Europe   EN	France   AFNOR	GB   BS	Italy   UNI	Sweden   SIS	Spain   UNE	Japan   JIS	USA   AISI
1.3910	Magnifer® 36	Ni36	D 1							
1.3926	Magnifer® 50	RNi12								
1.4361	X1CrNiSi1815	X 1 CrNiSi 18-15-4	X 1 CrNiSi 18 15 4							
1.4562	Nicrofer® 3127	X1NiCrMoCu32287	X 1 NiCrMoCu 32 28 7							
1.4562	Alloy 31	X1NiCrMoCu32287	X 1 NiCrMoCu 32 28 7							
1.4563	Sanicro® 28	X1NiCrMoCuN31274	X 1 NiCrMoCuN 31-27-4	X 1 NiCrMoCuN 31 27 4		X 1 NiCrMoCuN 31 27 4	2584			
1.4862	INCOLOY® Alloy DS	X12NiCr3618		Z 12 NCS 37.18	NA 17					
1.4980	INCOLOY® Alloy 286	X6NiCrTiMoVB21152	X 6 NiCrTiMoVB 21 15 2	Z 6 NCTDV 25.15 B	286 S 31					
2.4478	Alloy 52 (Nilo® 52)	FeNi 52	Titan Grade 4	AIR:9182T60	2 TA 6-9					N 14052

### S 1.2 NICKEL-BASED ALLOY [HRSA] <1450 N/mm<sup>2</sup>

Material-number	Tradename	Germany   DIN	Europe   EN	France   AFNOR	GB   BS	Italy   UNI	Sweden   SIS	Spain   UNE	Japan   JIS	USA   AISI
2.4602	INCONEL® 622	NiCr21Mo14W				INCONEL® 622				
2.4632	Nimonic® 90	NiCr20Co80Ti	HR 2	NC 20 KTA	NA 36	Nimonic® 90				N 07090
2.4642	INCONEL® 690	NiCr29Fe		NC 30 Fe		INCONEL® 690			NCF 690	N 06690
2.4650	Nimonic® C-263	NiCo20Cr20MoTi	HR 10	NCK 20 D	NA 38	Nimonic® C-263			NCF 690	N 07263
2.4654	Waspaloy®	NiCr19Co14Mo4Ti		NC 20 K14 Y		Waspaloy®				N 07001
2.4662	INCOLOY® 901	NiCr13Mo6Ti3		Z 8 NCDT 42						N 09901
2.4663	INCONEL® 617	NiCr23Co12Mo		NC 22 K12 D9 A		INCONEL® 617				N 06617
2.4665	Hastelloy® X	NiCr22Fe18Mo	HR 6	NC 22 FeD	NA 40	Hastelloy X				
2.4666	Nimonic® PK25	NiCr18CoMo		NKCD 20 ATU						
2.4668	INCONEL® 718	NiCr19FeNbMo	HR 8	NC 19 Fe Nb	INCONEL® 718	INCONEL® 718				N 07718
2.4669	INCONEL® X-750	NiCr15Fe7TiAl		NC 15 Fe 7 TA		INCONEL® X-750				N 07750
2.4694	INCONEL® 751	NiCr16Fe7TiAl								N 07751
2.4816	INCONEL® 600	NiCr15Fe		NC 15 Fe	NA 14	INCONEL® 600			NFC 600	N 06600
2.4819	Nimonic® C-276	NiMo16Cr15W		NC 17 D		Nimonic® C-276				N 10276
2.4851	INCONEL® 601	NiCr23Fe15		NC 23 Fe 14 A		INCONEL® 601			NCF 601	N 06601
2.4856	INCONEL® 625	NiCr22Mo9Nb		NC 22 Fe DNb	NA 21	INCONEL® 625			NCF 625	N 06625
2.4858	INCOLOY® 825	NiCr21Mo	3072.76	NC 21 Fe DU	NA 16	INCOLOY® 825			NCF 825 TB	N 08825
2.4869	Alloy 80/20	NiCr80-20								N 06003
2.4879	Centralloy® 4879	G-NiCr38W								
2.4883	Hastelloy® C276	G-NiMo16Cr								
2.4889	Nicrofer® 45 TM	NiCr28FeSiCe								N 06045
2.4951	Nicrofer® 7520	NiCr20Ti		NC 20 T	HR 5					N 06075

### S 1.3 COBALT-BASED ALLOY [HRSA] <1450 N/mm<sup>2</sup>

Material-number	Tradename	Germany   DIN	Europe   EN	France   AFNOR	GB   BS	Italy   UNI	Sweden   SIS	Spain   UNE	Japan   JIS	USA   AISI
2.4681	ULTIMET® alloy	CoCr26Ni9Mo5W								
2.4682	Stellite® 31	G-CoCr25NiW		KC 25 WN						ASTM A567
2.4683	Conicro® 4023 W	CoCr22NiW								
2.4691	HS 21	G-CoCr28Mo		KC 27 D5 NFe						ASTM F-75
2.4964	Stellite® 25	CoCr20W15Ni		KC 22 WN	HR 240	L605 Haynes® 25				R 30605
2.4979	S 816	CoCr28Mo6								

## Technical formulas

Calculate cutting speed (m/min)

$$V_c = \frac{D \cdot \pi \cdot n}{1000}$$

Calculate rotational speed (rpm)

$$n = \frac{V_c \cdot 1000}{D \cdot \pi}$$

Calculate feed rate (mm/min)

$$V_f = n \cdot z \cdot f_z$$

Calculate feed per tooth (mm/number of teeth)

$$f_z = \frac{V_f}{n \cdot z}$$

Calculate chip removal rate (cm<sup>3</sup>/min)

$$Q = \frac{a_p \cdot a_e \cdot V_f}{1000}$$

Calculate average chip thickness (mm)

$$h_m = f_z \cdot \sqrt{\frac{a_e}{D}}$$

### Explanation of terms

<b>V<sub>c</sub></b>	Cutting speed	in m/min
<b>n</b>	Rotational speed	in rpm
<b>V<sub>f</sub></b>	Feed rate	in mm/min
<b>F<sub>z</sub></b>	Feed per tooth	in mm/number of teeth
<b>z</b>	Number of teeth (cutting)	
<b>a<sub>p</sub></b>	Depth of cut	in mm
<b>a<sub>e</sub></b>	Width of cut	in mm
<b>h<sub>m</sub></b>	Average chip thickness	in mm
<b>Q</b>	Chip removal rate	in cm <sup>3</sup> /min
<b>D</b>	Diameter of tool	in mm