

Cooling

Tolerance d04

Coating AlphaSlide Rainbow

Strategy **HSC**

Application





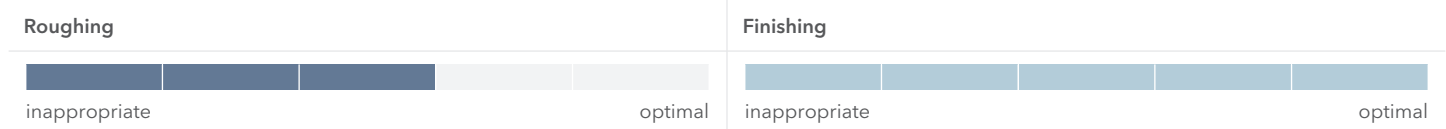
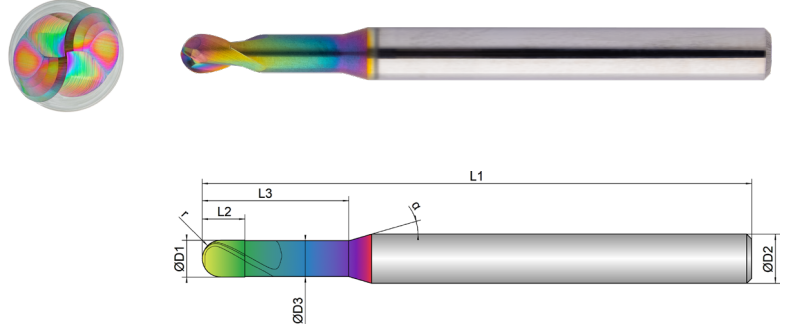

Features **HA**



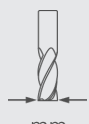
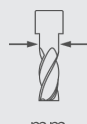

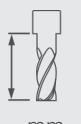
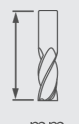
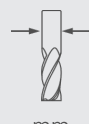

- Optimized face geometry for excellent surfaces and highest dimensional accuracy
 - Defined microbevel for support and stabilization
 - Polished chip space for ideal chip evacuation
- Tolerance D1: -0.001/-0.006 mm
 - Tolerance D3: 0/-0.02 mm
 - Radius tolerance r: 0/-0.003 mm (measured from 0-90°)

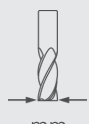
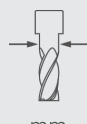
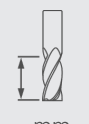
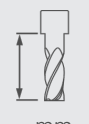
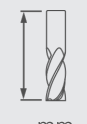
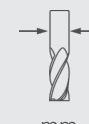

EXN1-M17-0003	D1 mm 	D3 mm 	L2 mm 	L3 mm 	L1 mm 	D2 mm 	z # 	r mm 		α °
0,1X0,3	0.1	0.08	0.08	0.3	45.0	4.0	2	0.05	30	16
0,1X0,5	0.1	0.08	0.08	0.5	45.0	4.0	2	0.05	30	16
0,1X1	0.1	0.08	0.08	1.0	45.0	4.0	2	0.05	30	16
0,2X0,5	0.2	0.17	0.16	0.5	45.0	4.0	2	0.10	30	16
0,2X1	0.2	0.17	0.16	1.0	45.0	4.0	2	0.10	30	16
0,2X2	0.24	0.17	0.16	2.0	45.0	4.0	2	0.10	30	16
0,2X3	0.2	0.17	0.16	3.0	45.0	4.0	2	0.10	30	16
0,3X0,5	0.3	0.27	0.24	0.5	45.0	4.0	2	0.15	30	16
0,3X1	0.3	0.27	0.24	1.0	45.0	4.0	2	0.15	30	16
0,3X2	0.3	0.27	0.24	2.0	45.0	4.0	2	0.15	30	16
0,3X3	0.3	0.27	0.24	3.0	45.0	4.0	2	0.15	30	16
0,3X4	0.3	0.27	0.24	4.0	45.0	4.0	2	0.15	30	16
0,3X6	0.3	0.27	0.24	6.0	45.0	4.0	2	0.15	30	16
0,4X1	0.4	0.37	0.32	1.0	45.0	4.0	2	0.20	30	16
0,4X2	0.4	0.37	0.32	2.0	45.0	4.0	2	0.20	30	16

EXN1-M17-0003	 mm ∅	 mm ∅	 mm	 mm	 mm	 mm ∅	 #	 mm	 °	 °
0,4X3	0.4	0.37	0.32	3.0	45.0	4.0	2	0.20	30	16
0,4X4	0.4	0.37	0.32	4.0	45.0	4.0	2	0.20	30	16
0,4X6	0.4	0.37	0.32	6.0	45.0	4.0	2	0.20	30	16
0,4X8	0.4	0.37	0.32	8.0	45.0	4.0	2	0.20	30	16
0,5X1	0.5	0.47	0.4	1.0	45.0	4.0	2	0.25	30	16
0,5X1,5	0.5	0.47	0.4	1.5	45.0	4.0	2	0.25	30	16
0,5X2	0.5	0.47	0.4	2.0	45.0	4.0	2	0.25	30	16
0,5X3	0.5	0.47	0.4	3.0	45.0	4.0	2	0.25	30	16
0,5X4	0.5	0.47	0.4	4.0	45.0	4.0	2	0.25	30	16
0,5X6	0.5	0.47	0.4	6.0	45.0	4.0	2	0.25	30	16
0,5X8	0.5	0.47	0.4	8.0	45.0	4.0	2	0.25	30	16
0,6X2	0.6	0.57	0.48	2.0	45.0	4.0	2	0.30	30	16
0,6X3	0.6	0.57	0.48	3.0	45.0	4.0	2	0.30	30	16
0,6X4	0.6	0.57	0.48	4.0	45.0	4.0	2	0.30	30	16
0,6X6	0.6	0.57	0.48	6.0	45.0	4.0	2	0.30	30	16
0,6X8	0.6	0.57	0.48	8.0	45.0	4.0	2	0.30	30	16
0,8X2	0.8	0.77	0.64	2.0	45.0	4.0	2	0.40	30	16
0,8X3	0.8	0.77	0.64	3.0	45.0	4.0	2	0.40	30	16
0,8X4	0.8	0.77	0.64	4.0	45.0	4.0	2	0.40	30	16
0,8X6	0.8	0.77	0.64	6.0	45.0	4.0	2	0.40	30	16
0,8X8	0.8	0.77	0.64	8.0	45.0	4.0	2	0.40	30	16
1X2	1.0	0.96	0.8	2.0	45.0	4.0	2	0.50	30	16
1X3	1.0	0.96	0.8	3.0	45.0	4.0	2	0.50	30	16
1X4	1.0	0.96	0.8	4.0	45.0	4.0	2	0.50	30	16
1X5	1.0	0.96	0.8	5.0	45.0	4.0	2	0.50	30	16
1X6	1.0	0.96	0.8	6.0	45.0	4.0	2	0.50	30	16
1X8	1.0	0.96	0.8	8.0	45.0	4.0	2	0.50	30	16

EXN1-M17-0003	D1	D3	L2	L3	L1	D2	z	r		α
	 mm \varnothing	 mm \varnothing	 mm	 mm	 mm	 mm \varnothing	 #	 mm	 °	 °
1X10	1.0	0.96	0.8	10.0	50.0	4.0	2	0.50	30	16
1X12	1.0	0.96	0.8	12.0	50.0	4.0	2	0.50	30	16
1,2X3	1.2	1.16	0.96	3.0	45.0	4.0	2	0.60	30	16
1,2X4	1.2	1.16	0.96	4.0	45.0	4.0	2	0.60	30	16
1,2X6	1.2	1.16	0.96	6.0	45.0	4.0	2	0.60	30	16
1,2X8	1.2	1.16	0.96	8.0	45.0	4.0	2	0.60	30	16
1,2X10	1.2	1.16	0.96	10.0	45.0	4.0	2	0.60	30	16
1,2X12	1.2	1.16	0.96	12.0	50.0	4.0	2	0.60	30	16
1,2X20	1.2	1.16	0.96	20.0	55.0	4.0	2	0.60	30	16
1,5X3	1.5	1.44	1.2	3.0	45.0	4.0	2	0.75	30	16
1,5X4	1.5	1.44	1.2	4.0	45.0	4.0	2	0.75	30	16
1,5X6	1.5	1.44	1.2	6.0	45.0	4.0	2	0.75	30	16
1,5X8	1.5	1.44	1.2	8.0	45.0	4.0	2	0.75	30	16
1,5X10	1.5	1.44	1.2	10.0	45.0	4.0	2	0.75	30	16
1,5X12	1.5	1.44	1.2	12.0	50.0	4.0	2	0.75	30	16
1,8X8	1.8	1.74	1.44	8.0	45.0	4.0	2	0.90	30	16
1,8X10	1.8	1.74	1.44	10.0	45.0	4.0	2	0.90	30	16
1,8X12	1.8	1.74	1.44	12.0	50.0	4.0	2	0.90	30	16
2X4	2.0	1.94	1.6	4.0	45.0	4.0	2	1.00	30	16
2X6	2.0	1.94	1.6	6.0	45.0	4.0	2	1.00	30	16
2X8	2.0	1.94	1.6	8.0	45.0	4.0	2	1.00	30	16
2X10	2.0	1.94	1.6	10.0	45.0	4.0	2	1.00	30	16
2X12	2.0	1.94	1.6	12.0	45.0	4.0	2	1.00	30	16
3X6	3.0	2.92	3.5	6.0	45.0	4.0	2	1.50	30	16
3X8	3.0	2.92	3.5	8.0	45.0	4.0	2	1.50	30	16
3X10	3.0	2.92	3.5	10.0	45.0	4.0	2	1.50	30	16
3X12	3.0	2.92	3.5	12.0	45.0	4.0	2	1.50	30	16



Download Catalog Pages (PDF)

Dimension	Ø0.1x0.3	Ø0.1x1	Ø0.2x0.5	Ø0.2x3	Ø0.3x0.5	Ø0.3x6	Ø0.4x1	Ø0.4x8	Ø0.5x1	Ø0.5x8
Infeed in mm	ae=0.1xD ap=0.1xD	ae=0.05xD ap=0.05xD	ae=0.1xD ap=0.1xD	ae=0.02xD ap=0.02xD	ae=0.1xD ap=0.1xD	ae=0.01xD ap=0.01xD	ae=0.1xD ap=0.1xD	ae=0.01xD ap=0.01xD	ae=0.1xD ap=0.1xD	ae=0.015xD ap=0.015xD
Application										

Material	Strength (N/mm ²)	Feed (mm/Z)	Vc (m/min)	fz	fz	fz	fz	fz	fz	fz	fz	fz	
N	NON-FERROUS												
1.1	ALUMINIUM alloyed	<500	500	0.012	0.007	0.014	0.008	0.014	0.008	0.018	0.009	0.016	0.012
1.2	ALUMINIUM alloyed	<600	480	0.012	0.007	0.014	0.008	0.014	0.008	0.018	0.009	0.016	0.012
2.1-2.3	ALUMINIUM cast	<600	450	0.011	0.006	0.013	0.007	0.013	0.007	0.017	0.008	0.015	0.011
3.1-3.3	COPPER alloyed	<650	220	0.01	0.005	0.012	0.006	0.012	0.006	0.016	0.007	0.014	0.01
4.1	MAGNESIUM alloyed	<250	500	0.012	0.007	0.014	0.008	0.014	0.008	0.018	0.009	0.016	0.012
5.1	PLASTICS Thermoplastic	<100	400	0.011	0.006	0.013	0.007	0.013	0.007	0.017	0.008	0.015	0.011
5.2	PLASTICS Duroplastic	<150	350	0.01	0.005	0.012	0.006	0.012	0.006	0.016	0.007	0.014	0.01

Dimension	Ø0.6x2	Ø0.6x8	Ø0.8x2	Ø0.8x8	Ø1x2	Ø1x12	Ø1.2x3	Ø1.2x20	Ø1.5x3	Ø1.5x12
Infeed in mm	ae=0.1xD ap=0.1xD	ae=0.025xD ap=0.025xD	ae=0.1xD ap=0.1xD	ae=0.05xD ap=0.05xD	ae=0.1xD ap=0.1xD	ae=0.03xD ap=0.03xD	ae=0.1xD ap=0.1xD	ae=0.015xD ap=0.015xD	ae=0.1xD ap=0.1xD	ae=0.07xD ap=0.07xD
Application										

Material	Strength (N/mm ²)	Feed (mm/Z)	Vc (m/min)	fz	fz	fz	fz	fz	fz	fz	fz	fz	
N	NON-FERROUS												
1.1	ALUMINIUM alloyed	<500	500	0.022	0.017	0.022	0.017	0.035	0.028	0.035	0.025	0.035	0.03
1.2	ALUMINIUM alloyed	<600	480	0.022	0.017	0.022	0.017	0.035	0.028	0.035	0.025	0.035	0.03
2.1-2.3	ALUMINIUM cast	<600	450	0.021	0.016	0.021	0.016	0.032	0.026	0.032	0.023	0.032	0.027
3.1-3.3	COPPER alloyed	<650	220	0.02	0.015	0.02	0.015	0.029	0.024	0.029	0.021	0.029	0.024
4.1	MAGNESIUM alloyed	<250	500	0.022	0.017	0.022	0.017	0.035	0.028	0.035	0.025	0.035	0.03
5.1	PLASTICS Thermoplastic	<100	400	0.021	0.016	0.021	0.016	0.032	0.026	0.032	0.023	0.032	0.027
5.2	PLASTICS Duroplastic	<150	350	0.02	0.015	0.02	0.015	0.029	0.024	0.029	0.021	0.029	0.024







Dimension	Ø1.8x8	Ø1.8x12	Ø2x4	Ø2x12	Ø3x6	Ø3x12
Infeed in mm	ae=0.1xD ap=0.1xD	ae=0.09xD ap=0.09xD	ae=0.1xD ap=0.1xD	ae=0.09xD ap=0.09xD	ae=0.1xD ap=0.1xD	ae=0.1xD ap=0.1xD
Application						

Material	Strength (N/mm ²)	Feed (mm/Z)	Vc (m/min)	fz	fz	fz	fz	fz	fz
N	NON-FERROUS								
1.1	ALUMINIUM alloyed	<500	500	0.04	0.035	0.04	0.035	0.043	0.04
1.2	ALUMINIUM alloyed	<600	480	0.04	0.035	0.04	0.035	0.043	0.04
2.1-2.3	ALUMINIUM cast	<600	450	0.035	0.032	0.035	0.032	0.038	0.035
3.1-3.3	COPPER alloyed	<650	220	0.03	0.029	0.03	0.029	0.033	0.03
4.1	MAGNESIUM alloyed	<250	500	0.04	0.035	0.04	0.035	0.043	0.04
5.1	PLASTICS Thermoplastic	<100	400	0.035	0.032	0.035	0.032	0.038	0.035
5.2	PLASTICS Duroplastic	<150	350	0.03	0.029	0.03	0.029	0.033	0.03

ADVICE | Values in the table are the shortest and the longest overhang length (L3) of each dimension; please calculate fz, ap and ae depending on the given values.

EXPLANATION

























APPLICATIONS

 Multipass milling	 Trimming	 Deburring	 Engraving
 Corner rounding	 Full slot milling	 Forward and backward deburring	





COOLINGS

 Air-cooling	 Dry machining	 Oil cooling	 Cooling Lubricant
 Minimum quantity lubrication			

FEATURES







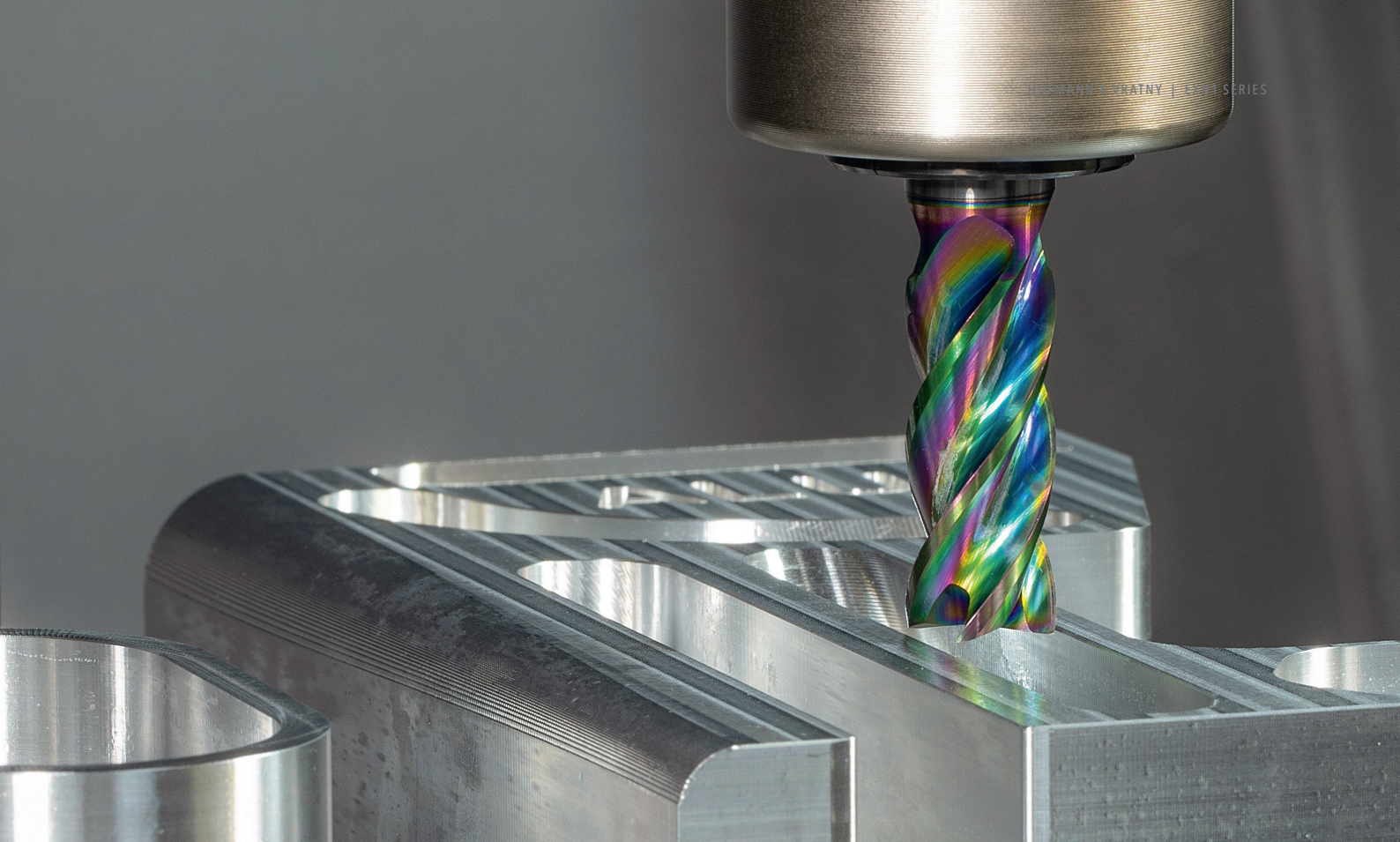









 0,5xD	 1xD	 1,5xD	 2xD
 2,5xD	 3xD	 3,5xD	 4xD
 5xD	 Center cutting	 Non-center cutting	 Without Weldon
 With Weldon	 Internal cooling	 Dynamic helical pitch	 Chip breaker
 Unequal tooth pitch	 Roughing teeth	 Helical immersion	 Feed directions x,y
 Feed directions x, y, z	 Feed directions x, y, (z)	 Corner radius	 Corner bevel
 Sharp edged			

STRATEGY

 Extended Trochoidal Cutting	 High Performance Cutting	 High Speed Cutting	 Multi Task Cutting
 Universal Machining			



PROPERTIES

 Cutting diameter	 Small cutting diameter	 Large cutting diameter	 Undercut diameter
 Cutting length	 Total bevel length	 Undercut length	 Total length
 Shank diameter	 Number of teeth	 Corner radius	 Corner bevel
 Programming radius	 Maximum cutting depth	 Helical angle	 Alpha angle

APPLICATION TABLE

The values given in the application table are only guidelines. These values are largely dependent on the machining situation and application.

FIGURES

All technical drawings and photographs are given as an example. The product may deviate from the original in terms of colour and dimensions.

N 1.1 ALUMINIUM | alloyed <500 N/mm²

Materialnumber	Germany DIN	Europe EN	France AFNOR	Great Britain BS	Italy UNI	Sweden SIS	Spain UNE	Japan JIS	USA AISI
3.0205	Al99	AW-1200	A 4	1 C	P-Al99,0	4010	L-3001	A1200	AA1200
3.0250	Al99.5H		A 59050 C	L 31					AA1000
3.0255	Al99.5	AW-1050 A	A 5	L 31	P-AIP99.5	4007	L-3051	A1050	AA1050 A
3.0275	Al99.7	AW-1070 A	A 7	2L 48	P-AIP99.7	4005	L-3071	A1070	AA1070 A
3.0280	Al99.8								
3.0285	Al99.8	AW-1080 A	A 8	1A	P-Al99.8	4004	L-3081	A1080	AA1080 A
3.0305	Al99.9	AW-1090							
3.0505	AlMn 0.5 Mg 0.5	AW-3105		N 31				A3105	AA3105
3.0506	AlMn 0.6	AW-3207							
3.0515	AlMn 1	AW-3103		N 3	P-AlMn 1.2	4067	L-3811	A3103	AA3103
3.0517	AlMn 1 Cu	AW-3003	A-M1		P-AlMn 1.2 Cu		L-3810	A3003	AA3003
3.0525	AlMn 1 Mg 0.5	AW-3005	A-MG0,5					A3005	AA3005
3.0526	AlMn 1 Mg 1	AW-3004	A-M1G		P-AlMn 1.2 Mg	GA/6511	L-3820	A3004	AA3004
3.0915	AlFeSi	AW-8011A							
3.1255	AlCu 4 SiMg	AW-2014	A-U45G	H 15	P-AlCu 4.4 SiMnMg		L-3130	A2014	AA2014
3.1305	AlCu 2.5 Mg	AW-2117	A-U2G	L 86	P-AlCu 2.5 MgSi		L-3180	A2117	AA2117
3.1324	AlCu 4 MgSi	AW-2017 A							
3.1325	AlCuMg1	AW-2017 A	A-U4G	H 14	P-AlCu 4.5 MgMn	GA631	L-3120	A2017	AA2017 A
3.1355	AlCuMg2	AW-2024	A-U4G1	L 97 / L 98	P-AlCu 4.5 MgMn	5	L-3140	A2024	AA2024
3.1371	G-AlCu 4 TiMg	AC-21000							
3.1841	G-AlCu 4 Ti	AC-21100							
3.2134	G-AlSi 5 Cu 1,3 Mg	AC-45300							
3.2307	Al99.85 MgSi								
3.2315	AlMgSi 1	AW-6082	A-SGM0,7	H 30	P-AlMgSi	4212	L-3453		AA6082
3.3206	AlMgSi 0.5	AW-6060	A-GS	H 9	P-AlMgSi	4140	L-3442		AA6060
3.3208	Al99.9 MgSi	AW-6401							
3.3210	AlMgSi 0.7	AW-6005 A							
3.3211	AlMg 1 SiCu	AW-6061	A-GSUC	H 20	P-AlMg 1 SiCu		L-3420	A6061	AA6061
3.3241	G-AlMg 3 Si								
3.3261	G-AlMg 5 Si	AC-51400							
3.3292	GD-AlMg 9	AC-51200							
3.3307	Al99.85 Mg 0.5	AW-5110							
3.3308	Al99.9 Mg 0.5	AW-5210							
3.3315	AlMg1	AW-5005 A	A-G0,6	N 41	P-AlMg 0.9	4106	L-3350	A5005	AA5005 A
3.3316	AlMg 1.5	AW-5050	A-G1,5	3L 44	P-AlMg 1.5		L-3380		AA5050 B
3.3317	Al99.85 Mg 1	AW-5305							
3.3318	Al99.9 Mg 1	AW-5505							
3.3326	AlMg 1.8	AW-5051 A							
3.3345	AlMg 4.5	AW-5082	A-G4,5		P-AlMg 4.4			A5082	AA5082
3.3523	AlMg 2.5	AW-5052	A-G2,5C	L 80 / L 81	P-AlMg 2.5	4120	L-3360	A5052	AA5052
3.3525	AlMg 2 Mn 0.3	AW-5251	A-G2M	N4	P-AlMg 2 Mn		L-3361		AA5251
3.3527	AlMg 2 Mn 0.8	AW-5049	A-G2,5MC					A5049	AA5049
3.3535	AlMg 3	AW-5754	A-G3M		P-AlMg 3.5	4130	L-3390		AA5754
3.3537	AlMg 2.7 Mn	AW-5454	A-G2,5MC		P-AlMg 2.7 Mn	4130	L-3391		AA5454
3.3541	G-AlMg 3	AC-51100							
3.3545	AlMg 4 Mn	AW-5086	A-G4MC		P-AlMg 4.4		L-3382		AA5086
3.3547	AlMg 4.5 Mn	AW-5083	A-G4,5MC	N 8	P-AlMg 4.5	4140	L-3321	A5083	AA5083
3.3549	AlMg 5 Mn	AW-5182							
3.3555	AlMg 5	AW-5019							
3.3561	G-AlMg 5	AC-51300							

N 1.2 ALUMINIUM | alloyed <600 N/mm²

Materialnumber	Germany DIN	Europe EN	France AFNOR	Great Britain BS	Italy UNI	Sweden SIS	Spain UNE	Japan JIS	USA AISI
3.0615	AlMgSiPb	AW-6012	A-SGPb		P-AlSiMgMn		L-3452		AA6012
3.1645	AlCu 4 PbMgMn	AW-2007				4355	L-3121	A2007	AA2007
3.1655	AlCu 6 BiPb	AW-2011	A-U5PbBi	FC 1	P-AlCu 5.5 PbBi	4338	L-3192	A2011	AA2011
3.4335	AlZn 4.5 Mg 1	AW-7020	A-Z5G	H 17		4425	L-3741		AA7020
3.4345	AlZnMgCu 0.5	AW-7022	A-Z4GU						AA7022
3.4365	AlZnMgCu 1.5	AW-7075	A-Z5GU	2L 95	P-AlZn 5.8 MgCu		L-3710	A7075	AA7075

N 2.1 - N 2.3 ALUMINIUM | cast <600 N/mm²

Materialnumber	Germany DIN	Europe EN	France AFNOR	Great Britain BS	Italy UNI	Sweden SIS	Spain UNE	Japan JIS	USA AISI
3.1841	G-AlCu 4 Ti							AC1A	A 295.0
3.1871	G-AlCu 4 TiMg								
3.2131	G-AlSiCu1								
3.2151	G-AlSi 6 Cu 4	AC-45000	A-S5UZ	LM 4				AC4B	A 319.0
3.2161	G-AlSi 8 Cu 3	AC-46200	A-S9U3A-Y4	LM 24	5075			AC4D	A 328.0
3.2163	GD-AlSi 9 Cu 3								
3.2211	G-AlSi 11								
3.2341	G-AlSi 5 Mg								
3.2371	G-AlSi 7 Mg 0,3	AC-42100						AC4CH	A 356.0
3.2373	G-AlSi 9 Mg	AC-43300							
3.2381	G-AlSi 10 Mg	AC-43100							
3.2382	GD-AlSi 10 Mg								
3.2383	G-AlSi 10 Mg(Cu)	AC-43400	A-S10G	LM 9	3049	4253		ADC3	A 360.2
3.2581	G-AlSi 12	AC-47100	A-S13	LM 6	4514	4261		AC3A	A 413.2
3.2582	GD-AlSi 12					4247		ADC1	A 413.0
3.2583	G-AlSi 12 Cu	AC-44300	A-S12-Y4	LM 20	5079	4260		ADC1	A 413.1
3.2585	SG-AlSi12								
3.2982	GD-AlSi 12 Cu								
3.3241	G-ALMg 3 Si								
3.3261	G-ALMg 5 Si								
3.3561	G-ALMg 5							AC7A	A 514.0

N 3.1 COPPER | alloyed <600 N/mm²

Materialnumber	Germany DIN	Europe EN	France AFNOR	Great Britain BS	Italy UNI	Sweden SIS	Spain UNE	Japan JIS	USA AISI
2.0060	E-Cu 57	CW-004A							B-120
2.0065	E-Cu 58	CW-004A	Sn-a2	C 101					C 11000
2.0070	SE-Cu	CW-020A	Cu-c1	C 101					C 10300
2.0082	G-Cu L 45			HCC 1					C 81100
2.0085	G-Cu L 50	CC-040A		HCC 1					C 81100
2.0240	CuZn 15	CW-502L	CuZn 15	CZ 102				C 2300	C 23000
2.0265	CuZn 30	CW-505L	CuZn 30	CZ 102				C 2600	C 26000
2.0321	CuZn 37	CW-508L	CuZn 37	CZ 180	C 2720				C 27200
2.0340	G-CuZn 37 Pb	CC-754S-GM							
2.0492	G-CuZn 15 Si 4	CC-761S-GS							B-198
2.0592	G-CuZn 35 Al 1	CC-765S	U-Z 36 N 3	HTB 1					C 86500
2.0595	G-KCuZn 37 Al 1	CC-766S							
2.0596	G-CuZn 34 Al 2	CC-764S	U-Z 36 N 3						
2.0857	CuNi 3 Si	CW-112C							
2.0916	CuAl 5								
2.0927	SG-CuAl 9 Ni 5 Fe								
2.0936	CuAl 10 Fe 3 Mn 2	CW-306G	U-A 10 Fe	CA 103					
2.0966	CuAl 10 Ni 5 Fe 4	CW-307G	U-A 10 N	CA 104					C 63000
2.1006	SG-CuSn								
2.1050	G-CuSn 10	CC-480K-GS		CT 1					C 90700
2.1052	G-CuSn 12	CC-483K-GS	UE 12 P	Pb 2					C 91700
2.1060	G-CuSn 12 Ni 2	CC-484K-GS							C 91700
2.1090	G-CuSn 7 ZnPb		UE 7 Z5 Pb 4						C 93200
2.1093	G-CuSn 6 ZnNi			LG 4					
2.1096	G-CuSn 5 ZnPb		UE 5 Pb 5 Z 5	LG 2					C 83600
2.1176	G-CuPb 10 Sn	CC-495K-GS	UE 10 Pb 10	LB 2					C 93700
2.1182	G-CuPb 15 Sn	CC-496K-GS	U-Pb 15 E 8	LB 1					C 93800
2.1188	G-CuPb 20 Sn	CC-497K-GS	U-Pb 20	LB 5					C 94100
2.1266	CuCd 1								
2.1292	G-CuCrF 35	CC-140C		CC1-FF					C 81500
2.1293	CuCrZr	CW-106C	U-Cr 0.8 Zr	CC 102					C 81500
2.1322	CuMg 0.4								
2.1355	CuMn 2								
2.1461	SG-CuSi 3	CW-116C							

N 4.1 **MAGNESIUM** | alloyed <200 N/mm²

Materialnumber	Germany DIN	Europe EN	France AFNOR	Great Britain BS	Italy UNI	Sweden SIS	Spain UNE	Japan JIS	USA AISI
3.5101	G-MgZn 4 SE1 Zr 1	MC-35110	G-Z 4 Tr	MAG-5					ZE 41
3.5102	G-MgZn 5 Th2 Zr1								
3.5103	MgSE 3 Zn2 Zr1	MC-65120	G-Tr 3 Z 2	MAG-6					EZ 33
3.5105	G-MgTh 3 Zn2 Zr1								QE 22
3.5106	G-MgAg 3 SE2 Zr1	MC-65210	G-Ag 22.5	MAG-12					
3.5200	G-MgAl 8 Zn 1	MA-40020							
3.5312	MgAl 3 Zn	MA-21130							
3.5314	MgAl 3 Zn		G-A3 Z1	MAG-E-111					AZ 31 B
3.5470	GD-MgAl 4 Si 1	MC-21320							
3.5612	GD-MgAl 6 Zn 3	MC-21140							
3.5614	MgAl 6 Zn		G-A6 Z1	MAG-E-121					AZ 61 A
3.5662	GD-MgAl 6								
3.5812	G-MgAl 8 Zn 1	MC-21110	G-A9						AZ 81
3.5912	G-MgAl 9 Zn 1	MC-21120	G-A 9 Z 1						AZ 91

N 5.1 **PLASTICS** | thermoplastics <100 N/mm²

Materialnumber	Germany DIN	Europe EN	France AFNOR	Great Britain BS	Italy UNI	Sweden SIS	Spain UNE	Japan JIS	USA AISI
PC	Makralon		Orgalan	Sirvet					Lexan
PC	Nuclon								Merlon
PC	Plastocarbon								
PE	Baylon			Fertene	Carlona				Althon
PE	Dekalen			Eraclene	Escorene				Bakelite
PE	Lupolen								Chemplex
PE	Hostalen								Dylan
PF	Alberit			Fenachem					Biralit
PF	Bakelit			Moldesile					Biratex
PF	Bulitol								Birax
PF	Durax								
PF	Harex								
PF	Resinol								
PFTE	Hostaflon		Soreflon						Halon; Teflon
PP	Vestolen PP		Eitex P	Moplen	Carola P				Profax
PP	Synalen PP		Napryl	Kastilen	Procom				Rexene
PP	Novolen								Tenite
PP	Hostalen PP								
PS	Hostylon			Sdistir	Lustrex				Carinex
PS	Lorkalen			Lastinol					Dylene
PS	Polystyrol								Toporex
PS	Styropor								
PVC	Coroplast								
PVC	Hostalit								
PVC	Mipolam								
PVC	Opalon								
PVC	Solvec								
PVC	Vinoflex								
PP-H	Homopolymer								
PP-C	Copolymer								
ABS	Acrylnitrid Butadien Styrol								
PMMA	Polymethyl metha Crylat								
PMMA	Plexiglas; Resarit; Degluan								
POMC	Polyoxymethylen								
POMC	Hostaform; ultraform								
PI	Polymid								
PEI	Polytherimid								
PVC-H	Polyvinylchlorid (hard)								
PA	Polyamide								

N 5.2 PLASTICS | duroplastics <150 N/mm²

Materialnumber	Germany DIN	Europe EN	France AFNOR	Great Britain BS	Italy UNI	Sweden SIS	Spain UNE	Japan JIS	USA AISI
PUR 5220									
PF 31									
MP 183									

Technical formulas

Calculate cutting speed (m/min)

$$V_c = \frac{D \cdot \pi \cdot n}{1000}$$

Calculate rotational speed (rpm)

$$n = \frac{V_c \cdot 1000}{D \cdot \pi}$$

Calculate feed rate (mm/min)

$$V_f = n \cdot z \cdot f_z$$

Calculate feed per tooth (mm/number of teeth)

$$f_z = \frac{V_f}{n \cdot z}$$

Calculate chip removal rate (cm³/min)

$$Q = \frac{a_p \cdot a_e \cdot V_f}{1000}$$

Calculate average chip thickness (mm)

$$h_m = f_z \cdot \frac{\sqrt{a_e}}{D}$$

Explanation of terms

V_c	Cutting speed	in m/min
n	Rotational speed	in rpm
V_f	Feed rate	in mm/min
F_z	Feed per tooth	in mm/number of teeth
z	Number of teeth (cutting)	
a_p	Depth of cut	in mm
a_e	Width of cut	in mm
h_m	Average chip thickness	in mm
Q	Chip removal rate	in cm ³ /min
D	Diameter of tool	in mm

EXPLANATION OF CUTTING DATA

EXAMPLE FOR SIDE MILLING OF 3.2151 WITH Ø10:

N 2.1 - N 2.3 ALUMINIUM | cast <600 N/mm²

Materialnumber	Germany DIN	Europe EN	France AFNOR	Great Britain BS	Italy UNI	Sweden SIS	Spain UNE	Japan JIS	USA AISI
3.1841	G-AlCu 4 Ti							AC1A	A 295.0
3.1871	G-AlCu 4 TiMg								
3.2131	G-AlSiCu1								
3.2151	G-AlSi 6 Cu 4	AC-45000	A-SSUZ	LM 4				AC4B	A 319.0
3.2161	G-AlSi 8 Cu 3	AC-46200	A-S9U3A-Y4	LM 24	5075			AC4D	A 328.0

THE MATERIAL KEY WITH DETAILED BREAKDOWN OF MATERIALS BY MATERIAL GROUP CAN BE FOUND AT THE END OF THE CATALOGUE.

Material	Strength (N/mm ²)	Full Slot	Side Milling	Finishing	ETC	Materialgroup Factor fz / a	Materialgroup Factor ae ETC
		Vc = m/min	Vc = m/min	Vc = m/min	Vc = m/min		
N NON-FERROUS							
1.1 ALUMINIUM alloyed	<500	500	500	500	560	1	1
1.2 ALUMINIUM alloyed	<600	480	480	480	540	1	1
2.1-2.3 ALUMINIUM cast	<600	450	450	450	510	0.9	0.8
3.1-3.3 COPPER alloyed	<650	200	200	200	260	0.8	0.7
4.1 MAGNESIUM alloyed	<250	500	500	500	560	1	1
5.1 PLASTICS Thermoplastic	<100	400	400	400	460	0.7	0.8
5.2 PLASTICS Duroplastic	<150	350	350	350	410	0.6	0.7

OVERVIEW OF THE DIFFERENT MATERIAL GROUPS FOR THIS TOOL INCLUDING FACTORS

Material N 1.1

D1	L2	Immersion Angle α°	Full Slot			Side Milling			Finishing			ETC			
			fz (mm/Z)	ae = 1xD (mm)	ap = 1xD (mm)	fz (mm/Z)	ae = 0.3xD (mm)	ap (mm)	fz (mm/Z)	ae (mm)	ap (mm)	fz (mm/Z)	ae = 0.25xD (mm)	ap (mm)	hmax (mm)
2	6	1°	0.02	2	2	0.03	0.6	L2max	0.018	0.2	L2max	0.045	0.5	L2max	0.039
3	10	1°	0.03	3	3	0.04	0.9	L2max	0.02	0.2	L2max	0.055	0.75	L2max	0.0476
4	13	1.2°	0.04	4	4	0.05	1.2	L2max	0.021	0.2	L2max	0.07	1	L2max	0.0606
5	14	1.2°	0.045	5	5	0.065	1.5	L2max	0.023	0.2	L2max	0.08	1.25	L2max	0.0693
6	16	1.5°	0.05	6	6	0.07	1.8	L2max	0.025	0.2	L2max	0.1	1.5	L2max	0.0866
8	22	2°	0.07	8	8	0.09	2.4	L2max	0.03	0.2	L2max	0.12	2	L2max	0.1039
10	25	2.5°	0.09	10	10	0.1	3	L2max	0.035	0.2	L2max	0.14	2.5	L2max	0.1212
12	28	3°	0.1	12	12	0.13	3.6	L2max	0.04	0.2	L2max	0.16	3	L2max	0.1386
16	36	4°	0.12	16	16	0.15	4.8	L2max	0.045	0.2	L2max	0.18	4	L2max	0.1559
20	41	5°	0.15	20	20	0.18	6	L2max	0.05	0.2	L2max	0.22	5	L2max	0.1905

ALL DATA GIVEN HERE IS FOR THE FIRST GROUP N1.1 IN THE MATERIAL GROUP OVERVIEW

DETERMINATION OF CUTTING DATA:

From the material key results: material group N2.1-2.3

Vc = 450 m/min (as indicated in the table)

fz = 0.1 mm/Z (as indicated in the table) x Factor fz 0.9 = fz 0.09 mm/Z



VIDEO EXPLANATION

EXAMPLE FOR ETC MILLING OF PE WITH Ø10:

N 5.1 PLASTICS | thermoplastics <100 N/mm²

Materialnumber	Germany DIN	Europe EN	France AFNOR	Great Britain BS	Italy UNI	Sweden SIS	Spain UNE	Japan JIS	USA AISI
PC	Makralon		Orgalan	Sinvet					Lexan
PC	Nuclon								Merlon
PC	Plastocarbon								
PE	Baylon			Fertene	Carlona				Althlon
PE	Dekalen			Eraclene	Escorene				Bakelite

THE MATERIAL KEY WITH DETAILED BREAKDOWN OF MATERIALS BY MATERIAL GROUP CAN BE FOUND AT THE END OF THE CATALOGUE.

Material	Strength (N/mm ²)	Full Slot	Side Milling	Finishing	ETC	Materialgroup Factor fz / a	Materialgroup Factor ae ETC
		Vc = m/min	Vc = m/min	Vc = m/min	Vc = m/min		
NON-FERROUS							
1.1	ALUMINIUM alloyed	<500	500	500	500	1	1
1.2	ALUMINIUM alloyed	<600	480	480	480	1	1
2.1-2.3	ALUMINIUM cast	<600	450	450	450	0.9	0.8
3.1-3.3	COPPER alloyed	<650	200	200	200	0.8	0.7
4.1	MAGNESIUM alloyed	<250	500	500	500	1	1
5.1	PLASTICS Thermoplastic	<100	400	400	400	0.7	0.8
5.2	PLASTICS Duroplastic	<150	350	350	350	0.6	0.7

OVERVIEW OF THE DIFFERENT MATERIAL GROUPS FOR THIS TOOL INCLUDING FACTORS

Material N 1.1

D1	L2	Immersion Angle	Full Slot			Side Milling			Finishing			ETC			
			fz (mm/Z)	ae = 1xD (mm)	ap = 1xD (mm)	fz (mm/Z)	ae = 0.3xD (mm)	ap (mm)	fz (mm/Z)	ae (mm)	ap (mm)	fz (mm/Z)	ae = 0.25xD (mm)	ap (mm)	hmax (mm)
2	6	1°	0.02	2	2	0.03	0.6	L2max	0.018	0.2	L2max	0.045	0.5	L2max	0.039
3	10	1°	0.03	3	3	0.04	0.9	L2max	0.02	0.2	L2max	0.055	0.75	L2max	0.0476
4	13	1.2°	0.04	4	4	0.05	1.2	L2max	0.021	0.2	L2max	0.07	1	L2max	0.0606
5	14	1.2°	0.045	5	5	0.065	1.5	L2max	0.023	0.2	L2max	0.08	1.25	L2max	0.0693
6	16	1.5°	0.05	6	6	0.07	1.8	L2max	0.025	0.2	L2max	0.1	1.5	L2max	0.0866
8	22	2°	0.07	8	8	0.09	2.4	L2max	0.03	0.2	L2max	0.12	2	L2max	0.1039
10	25	2.5°	0.09	10	10	0.1	3	L2max	0.035	0.2	L2max	0.14	2.5	L2max	0.1212
12	28	3°	0.1	12	12	0.13	3.6	L2max	0.04	0.2	L2max	0.16	3	L2max	0.1386
16	36	4°	0.12	16	16	0.15	4.8	L2max	0.045	0.2	L2max	0.18	4	L2max	0.1559
20	41	5°	0.15	20	20	0.18	6	L2max	0.05	0.2	L2max	0.22	5	L2max	0.1905

ALL DATA GIVEN HERE IS FOR THE FIRST GROUP N1.1 IN THE MATERIAL GROUP OVERVIEW

DETERMINATION OF CUTTING DATA:

From the material key results: **material group N5.1**

Vc= 460 m/min (as indicated in the table)

fz= 0.14 mm/Z (as indicated in the table) x Factor fz 0.7 = **fz 0.098 mm/Z**

ae= 2.5 mm (as indicated in the table) x Factor ae 0.8 = **2.0 mm ae**