

Cooling	
Tolerance	e8
Coating	AlphaFerro Platin X

Strategy	ETC	HPC	
Application			
Features	HB	≠	

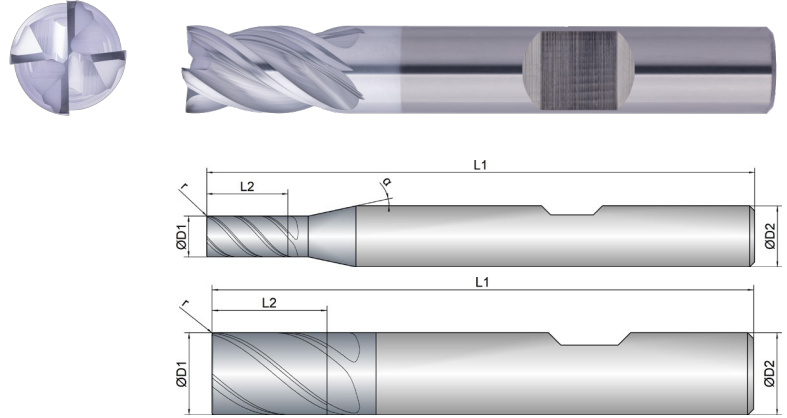

- Unequal tooth pitch combined with variable helical pitch for smooth running
 - Reinforced cutting edge with corner protection radius
 - Enlarged chip chambers for volume machining
-
- Designed for maximum removal rate when milling with high radial depth of cut and in the full slot up to 1xD
 - For process reliable ramping, helical immersion and diving (drilling) up to 1xD



Roughing







Finishing



	D1 mm ø	L2 mm	L1 mm	D2 mm ø	z #	r mm	 °	α °
3	3.0	6.0	54.0	6.0	4	0.10	40	12
4	4.0	8.0	54.0	6.0	4	0.10	40	12
5	5.0	9.0	54.0	6.0	4	0.20	40	12
6	6.0	10.0	54.0	6.0	4	0.20	40	0
8	8.0	12.0	58.0	8.0	4	0.20	40	0
10	10.0	14.0	66.0	10.0	4	0.20	40	0
12	12.0	16.0	73.0	12.0	4	0.20	40	0
16	16.0	22.0	82.0	16.0	4	0.30	40	0
20	20.0	26.0	92.0	20.0	4	0.30	40	0



Download Catalog Pages (PDF)

			Full Slot	Side Milling	Finishing	ETC	Materialgroup Factor fz / α	Materialgroup Factor ae ETC
								
Material	Strength (N/mm ²)		Vc = m/min	Vc = m/min	Vc = m/min	Vc = m/min		
P	STEEL							
1.1	unalloyed	<500	240	240	260	380	1	1
1.2-1.5	unalloyed	<1100	200	200	220	316	0.9	0.8
2.1-2.2	low-alloyed	<950	190	190	210	290	0.9	0.8
2.3-2.4	low-alloyed	<1300	160	160	180	203	0.8	0.75
3.1-3.2	high-alloyed	<1100	180	180	190	220	0.8	0.7
3.3	high-alloyed	<1400	150	150	160	196	0.7	0.68
K	CASTINGS							
1.1-1.2	Grey cast iron	<1000	220	220	230	262	0.9	0.8
2.1-2.2	Modular cast iron	<850	180	180	190	208	0.8	0.75
3.1-3.2	Malleable cast iron	<800	160	160	170	193	0.8	0.75
M	STAINLESS STEEL							
1.1	ferritic/martensitic	<850		90	95	172	0.9	0.6
2.1	austenitic	<650		75	80	146	0.8	0.45
2.2	austenitic	<750		70	75	128	0.75	0.4
3.1	DUPLEX STEEL super austenitic	<1100						







ADVICE | The values marked in turquoise are side applications!
 All fz/a values in the table for material group 1.1, consider factors for the other groups!
 When helical, ramping and drilling use fz 50 % of the full slot.
 The specified values represent starting values for a solid clamping situation.
 To determine the hmax values, please use the provided calculator.

Material P 1.1

D1 	L2 	Immersion Angle 	Full Slot			Side Milling			Finishing			ETC			
			fz (mm/Z)	ae = 1xD (mm)	ap = 1xD (mm)	fz (mm/Z)	ae = 0.3xD (mm)	ap (mm)	fz (mm/Z)	ae (mm)	ap (mm)	fz (mm/Z)	ae (mm)	ap (mm)	hmax (mm)
3	6	8°	0.025	3	3	0.03	0.9	L2max	0.018	0.2	L2max	0.045	0.8	L2max	0.0398
4	8	10°	0.025	4	4	0.03	1.2	L2max	0.018	0.2	L2max	0.06	1.1	L2max	0.0536
5	9	12°	0.035	5	5	0.04	1.5	L2max	0.02	0.2	L2max	0.07	1.3	L2max	0.0614
6	10	15°	0.045	6	6	0.05	1.8	L2max	0.025	0.2	L2max	0.09	1.6	L2max	0.0796
8	12	25°	0.055	8	8	0.065	2.4	L2max	0.03	0.2	L2max	0.12	1.9	L2max	0.1021
10	14	35°	0.06	10	10	0.075	3	L2max	0.035	0.2	L2max	0.14	2.3	L2max	0.1178
12	16	45°	0.065	12	12	0.085	3.6	L2max	0.04	0.2	L2max	0.17	2.6	L2max	0.1401
16	22	45°	0.08	16	16	0.1	4.8	L2max	0.045	0.2	L2max	0.19	3.3	L2max	0.1538
20	26	45°	0.1	20	20	0.12	6	L2max	0.05	0.2	L2max	0.22	3.6	L2max	0.169

EXPLANATION

























APPLICATIONS

 Multipass milling	 Trimming	 Deburring	 Engraving
 Corner rounding	 Full slot milling	 Forward and backward deburring	







COOLINGS

 Air-cooling	 Dry machining	 Oil cooling	 Cooling Lubricant
 Minimum quantity lubrication			

FEATURES







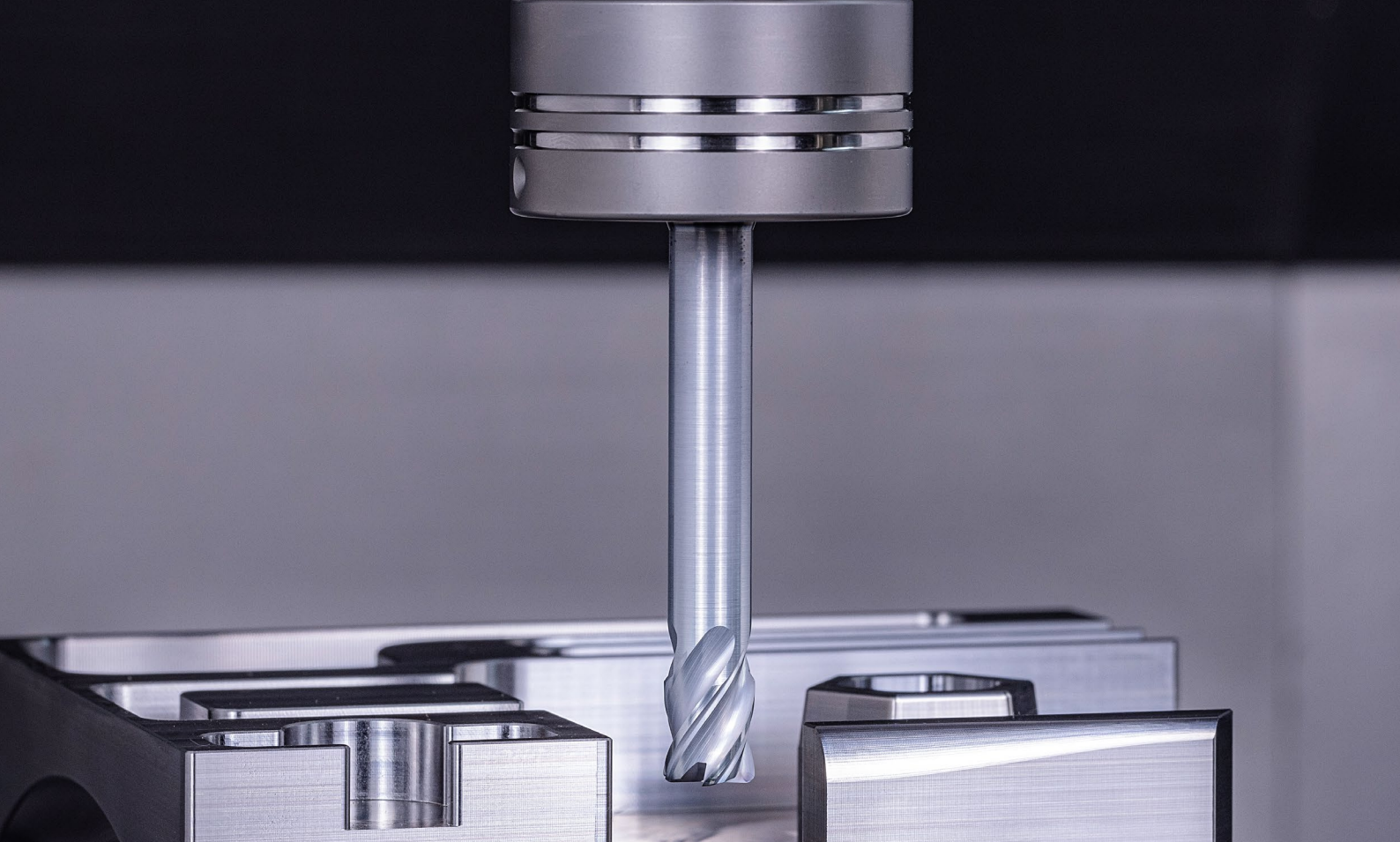









 0,5xD	 1xD	 1,5xD	 2xD
 2,5xD	 3xD	 3,5xD	 4xD
 5xD	 Center cutting	 Non-center cutting	 HA Without Weldon
 HB With Weldon	 Internal cooling	 Dynamic helical pitch	 Chip breaker
 ≠ Unequal tooth pitch	 Roughing teeth	 Helical immersion	 Feed directions x,y
 Feed directions x, y, z	 Feed directions x, y, (z)	 Corner radius	 45° Corner bevel
 90° Sharp edged			

STRATEGY

 ETC Extended Trochoidal Cutting	 HPC High Performance Cutting	 HSC High Speed Cutting	 HFC High Feed Cutting
 MTC Multi Task Cutting	 UNI Universal Machining		



PROPERTIES

 Cutting diameter	 Small cutting diameter	 Large cutting diameter	 Undercut diameter
 Cutting length	 Total bevel length	 Undercut length	 Total length
 Shank diameter	 Number of teeth	 Corner radius	 Corner bevel
 Programming radius	 Maximum cutting depth	 Helical angle	 Alpha angle

APPLICATION TABLE

The values given in the application table are only guidelines. These values are largely dependent on the machining situation and application.

FIGURES

All technical drawings and photographs are given as an example. The product may deviate from the original in terms of colour and dimensions.

P 1.1 **STEEL | unalloyed <500 N/mm²**

Materialnumber	Germany DIN	Europe EN	France AFNOR	Great Britain BS	Italy UNI	Sweden SIS	Spain UNE	Japan JIS	USA AISI
1.0498	ST42.8							STPT 42	
1.0044	ST442		E28-2	4360-43 B	Fe 430 BFN	1412	AE 275-B	SM 41 B	570 Gr. 40
1.0420	GS38	GE 200	230-400M			1306			
1.0446	GS45	GE 230	E23-45M	A1		1305	F.221	SC 450	
1.0136	St42-3								
1.0254	St37.0	P235T1						STPG 38	
1.1120	GS20Mn5							SMnC 420	
1.1121	Ck10	2 C 10	XC 10	040 A 10	C 10	1265	C 10 k	S 10 C	1010
1.1131	GS15Mn5								
1.1151	Ck22	2 C 22	XC 25	050 A 20	C 20		C 25 k	S 22 C	1023
1.5523	19MnB4			170 H 20			20 Mn B 4 DF	SWRCHB	
1.8961	WTS1373				Fe 360 D FF			SMA 50 A	
1.0035	ST33		A 33		FE 320			SS 330	
1.0037	ST37-2							STKR 400	
1.0710	15S10								
1.0715	95Mn28	11 SMn 28	S 250	230 M 07	CF 9 SMn 28	1912	11 SMn 28	SUM 22	1213
1.0718	95MnPb28	11 SMnPb28	S 250 Pb		CF 9SMnPb 28	1914	11 SMnPb 28	SUM 22 L	12 L 13
1.0721	10S20	10 S 20	10 F 1	210 M 15	CF 10 S 20		10 S 20		1108
1.0722	10SPb20	10 SPb 20	10 Pb F 2		CF 10 SPb 20		10 SPb 20		11 L 08
1.0736	95Mn36		S300	240 M 07	CF 9 SMn 36		12 SMn 35	SUM 25	1215
1.0737	95MnPb36		S 300 Pb		CF 9 SMnPb 36	1926	12 SMnPb 35		12 L 14

P 1.2 **STEEL | unalloyed <700 N/mm²**

Materialnumber	Germany DIN	Europe EN	France AFNOR	Great Britain BS	Italy UNI	Sweden SIS	Spain UNE	Japan JIS	USA AISI
1.0553	S244J0	S355J0	E 36-3	En 50 C	Fe 510 C FN			SM 520 M	S355J0
1.0581	ST52.4							STS 49	
1.1140	C15R	C15R	C15R	C15R			C 16 k-1		
1.1141	Ck15	2 C 15	XC 15	080 M 15	C 15	1370	C 16 k	S 15 C	1015
1.1190	S355G15								
1.0116	ST373		E 24-3	4360-40 C	Fe 37-3	1312	A 360 C		A 570 Gr. 36
1.0144	ST443		E 28-3	4360-43 C	Fe 430 D FF	1414	AE 275-D	SM 41 B	A 573 Gr. 70
1.0401	C15		CC12	080 M 15	C 15	1350	F.111	S 15 C	1015
1.0402	C22	1 C 22	CC 22	070 M 20	C 22		C 22 k	SFVC 1	
1.0406	C25	1 C 25	CC 25	070 M 26	C 25		C 25 k	S 22 C	1025
1.0461	STE255								
1.0482	19Mn5		A 52 CP	224-460				SG 37	
1.0486	STE285				FE E 285 KG		AE 285 KG	SM 41 A	
1.0501	C35	1 C 35	CC 35	060 A 35	C 35	1550	F.113	S 35 C	1035
1.0503	C45	1 C 45	CC 45	080 M 46	C 45	1650	C 45 k	S 45 C	1045
1.0505	STE315							SM 50 A	
1.0511	C40	1 C 40		080 M 40			F.114.A	S 40 C	1040
1.0528	C30	1 C 30	CC 32	080 M 30	C30			SUP 7	1030
1.0540	C50	1 C 50		080 M 50		1674		S 50 C	1050
1.0552	GS52	GE 260							
1.0558	GS60	GE 300	320-560M	A3	C 45	1606			
1.0562	STE355		E 355 R/FP		Fe E 355 KG	2132	AE 355 KG	SM 50 YB	A 633 Gr. C
1.0711	9520			220 M 07	CF 9 S 22			G 11120	1212
1.0970	38Si7		41 S 7						
1.1106	ESTE355			P 355 NL 2				STK 500	
1.1127	36Mn6			212 M 36				SMn 443	1141
1.1133	20Mn5			120 M 19	G 22 Mn3		20 Mn 6	SMn 420	1022
1.1169	20Mn6								
1.1520	C70W1				C 70 KU				
1.5637	10Ni14			503	18 Ni 14 KT				A 350-LF 5
1.8962	9CrNiCuP324			WR 50 A				SPA-H	
1.0726	35S20	35 S 20	35 MF 4	212 M 36		1957	F.210G		1140
1.0760	38SMn28	38SMn28	38SMn28	38SMn28			38SMn28		
1.1158	Ck25	2 C 25	XC 25	070 M 26	C 25		C 25 k	S 25 C	1025
1.1178	Ck30	2 C 30	XC 32	080 M 30	C30			S 30 C	1030
1.1181	Ck35	2 C 35	XC 38 H1	080 M 36	C35	1572	C 35 k	S 35 C	1034
1.1183	Cf35		XC 38 TS	060 A 35	C35	1572		S 35 C	1035
1.1191	Ck45	2 C 45	XC 42	080 M 46	C40		C45 k	S 45 C	1045
1.1206	Ck50	2 C 50		080 M 50	C50	1674		S 50 C	1050
1.1730	C45W	C 45 U	Y3 42						
1.5423	16Mo5			1503-245-420	16 Mo 5		16 Mo 5	SBC 690	4520

P 1.3 **STEEL** | unalloyed <850 N/mm²

Materialnumber	Germany DIN	Europe EN	France AFNOR	Great Britain BS	Italy UNI	Sweden SIS	Spain UNE	Japan JIS	USA AISI
1.1165	GS30Mn5		35 M 5	120 M 36		1330	30 Mn 5	SMn 433 H	1330
1.1525	C80W1	C 80 U	Y1 90		C 80 KU	1880	F.513		W 108
1.1545	C105W1	C 105 U	Y1 105	BW 1A	C 100 KU	1880	F.515		W 110
1.1620	C70W2	C 70 U							
1.1625	C80W2		Y1 80	BW 1B	C 80 KU		C 80	SKC 3	W 1
1.1645	C105W2						C 102	SK 3	
1.1663	C125W	C 120 U	Y2 120		C 120 KU		C 120	SK 2	W 112
1.1673	C135W		Y2 140		C 140 KU			SK 1	
1.1740	C60W		Y3 55					SK 7	
1.1820	C55W								
1.1830	C85W	C 90 U	Y3 90					SK 5	1084
1.1744	C67W		Y1 70				F.512		A-6
1.1750	C75W			BW 1A					W 1
1.5404	21MoV53								
1.5406	17MoV84								
1.5633	24Ni8	G 9 Ni 10	22 N 8		G 9 Ni 10			SCPL 21	
1.6311	20MnMoNi45	20 MnMoNi 4 5						SQV 2 B	
1.7242	16CrMo4	18 CrMo 4	15 CD 3.5		18 CrMo 4		18 CrMo 4	SCM 418 H	
1.7258	24CrMo4							SCM 822 H	
1.7259	26CrMo7								
1.7273	24CrMo10								
1.7337	16CrMo44				A18 CrMo 4 5 KW				A-387 Gr. 12 Cl. 2
1.7350	22CrMo44								
1.7362	12CrMo195	X 12 CrMo 5	Z 10 CD 5.05	3606-625	16 CrMo 20 5			SCMV 6	
1.7709	21CrMoV57	21 CrMoV 5 7	20 CDV 5.07						
1.7766	17CrMoV10								
1.7779	20CrMoV135								

P 1.4 **STEEL** | unalloyed <950 N/mm²

Materialnumber	Germany DIN	Europe EN	France AFNOR	Great Britain BS	Italy UNI	Sweden SIS	Spain UNE	Japan JIS	USA AISI
1.0062	ST601								
1.0532	ST522	S 390 G 1 S							
1.0535	C55	1 C 55	C 55	070 M 55	C 55	1655		C 55	1055
1.0570	ST523	S 355 J2 F3	E 36-3	4360-50 B	Fe 510 B	2132	A 510 C	SM 50 YB	
1.0728	60S20	60 S 20	60 MF 4						1151
1.1203	Ck55	2 C 55	XC 55 H1	070 M 55	C 55	1655	C 55 k	S 55 C	1055
1.7276	10CrMo11		12 CD 10						
1.7281	16CrMo93		20 CD 8						

P 1.5 **STEEL** | unalloyed <1100 N/mm²

Materialnumber	Germany DIN	Europe EN	France AFNOR	Great Britain BS	Italy UNI	Sweden SIS	Spain UNE	Japan JIS	USA AISI
1.0070	ST702		A 70-2		Fe 70-2		A 690-2		
1.0601	C60	1 C 60	AF 70 C 55	080 A 62	C 60			S 60 C-CSP	1060
1.1221	Ck60	2 C 60	XC 60	060 A 62	C 60	1678		S 58 C	1060
1.1223	Cm60	3 C 60	C 60 R	080 A 67	C 60 R				
1.0603	C67W								

P 2.1 **STEEL | low alloyed <750 N/mm²**

Materialnumber	Germany DIN	Europe EN	France AFNOR	Great Britain BS	Italy UNI	Sweden SIS	Spain UNE	Japan JIS	USA AISI
1.0961	60SiCr7	60 SiCr 8	60 SC 7	250 A 61	60 SiCr 8		60 SiCr 8	SUP 7	9262
1.2101	62SiMnCr4								
1.2162	21MnCr5	21 MnCr 5	20 NC 5					SCR 420 H	
1.2208	31CrV3								
1.2210	115CrV3	107 CrV 3 KU	100 C 3		107 CrV 3 KU		F.520.L		L2
1.2235	80CrV2						F.520.J		
1.2241	51CrV4	51 CRMnV 4			51 CrMnV 4 KU				S6
1.2307	29CrMoV9								
1.2323	48CrMoV67		45 CDV 6						
1.2382	GX155CrVMo121								
1.2414	120W4						F.532		
1.2542	45WCrV7	45 WCrV 8		BS 1	45 WCrV 8 KU	2710	45 WCrSi 8		S1
1.2552	80WCrV8						60 WCrSi 8		
1.2726	26NiCrMoV5								
1.2737	28NiCrV5								
1.2738	40CrMnNiMo864	40CrMnNiMo8-6-4							
1.2826	60MnSi4		60 MSC 4						
1.2838	145V33								
1.2842	90MnCrV8	90 MnV 8	90 MV 8	BO 2	90 MnVCr 8 KU				O 2
1.5752	14NiCr14	13 NiCr 12	16 NC 12	655 M 13	16 NiCr 11			SNC 815 H	E3310
1.5919	15CrNi6	14 CrNi 6	16 NC 6	S 107	16 CrNi 4			SNCM 420	
1.7003	38Cr2	38 Cr 2 KD	38 C 2	120 M 36	38 Cr 3		38 Cr 3	SMn 438	50 B40
1.7012	13Cr2								
1.7045	42Cr4	40 NiCrMo 3	42 C 4 TS	530 A 40	41 Cr 4	2245	42 Cr 4	SCr 440	5140
1.7103	67SiCr5	67 SiCr 5			67 SiCr 5				
1.7131	16MnCr5	16 MnCr 5 KD	16 MC 5	527 M 17	16 MnCr 5	2173	16 MnCr 5	SCR 415	5115
1.7271	23CrMoB33								
1.7715	14MoV63	14 MoV 6-3		1503-660-440			13 MoCrV 6		
1.8907	STES500							SM 58	
1.8911	ESTE380								

P 2.2 **STEEL | low alloyed <950 N/mm²**

Materialnumber	Germany DIN	Europe EN	France AFNOR	Great Britain BS	Italy UNI	Sweden SIS	Spain UNE	Japan JIS	USA AISI
1.0902	46Si7		45 S7				46 Si 7		
1.0906	65Si7			250 A 61					
1.0985	QSTE500N								
1.1157	40Mn4		35 M 5	150 M 36					1039
1.1167	36Mn5		40 M 5	150 M 36		2120	36 Mn 5		1335
1.1170	28Mn6	28 Mn 6	35 M 5	150 M 17	C 28 Mn		36 Mn 6	SCMn 1	1330
1.1199	49MnV53			280 M 01					
1.2002	125Cr1		Y2 120 C						
1.2003	75Cr1		35 M 5	150 M 36					
1.2004	85Cr1		Y1 100 C 2						
1.2008	140Cr3		Y2 140 C					SKS 8	
1.2056	90Cr3								
1.2057	105Cr4						F.120.J	SKC 11	
1.2108	90CrSi5	P 280 GH			C 100 KU	2092		SFVC 2A	
1.2109	125CrSi5								
1.2127	105MnCr4				100 CrMn 4 KU			SUJ 3	
1.2206	140CrV1		130 C 3						O 6
1.2242	59CrV4								
1.2243	61CrSiV5								
1.2249	45SiCrV6								
1.2303	100CrMo5						F.520.F		L 7
1.2312	40CrMnMoS86		40 CMD 8						
1.2519	110WCrV5						102 WCrV 5		
1.2562	142WV13								
1.2740	28NiCrMoV10								
1.2743	60NiCrMoV124								

P 2.2 STEEL | low alloyed <950 N/mm²

Materialnumber	Germany DIN	Europe EN	France AFNOR	Great Britain BS	Italy UNI	Sweden SIS	Spain UNE	Japan JIS	USA AISI
1.2747	28NiMo17								
1.2766	35NiCrMo16								
1.2851	34CrAl6								
1.3501	100Cr2		100 C 2						E 50100
1.3503	105Cr4								E51100
1.3505	100Cr6	100 Cr 6	100 C 6	535 A 99	100 Cr 6	2258	100 Cr 6	SUJ 2	E52100
1.3520	100CrMn6	100 Cr Mn 6	100 CM 6				100 CrMn 6		

P 2.3 STEEL | low alloyed <1100 N/mm²

Materialnumber	Germany DIN	Europe EN	France AFNOR	Great Britain BS	Italy UNI	Sweden SIS	Spain UNE	Japan JIS	USA AISI
1.2419	105WCr6	105 WCr 5	105 WC 13		107 WcR 5 KU	2140	105 WCr 5	SKS 31	
1.2511	80WCrV3								
1.2515	100WV4							SKS 21	
1.3561	44Cr2	46 Cr 1 KD	44 Cr 2						5046
1.3563	43CrMo4		43 CrMo 4						4142
1.3565	48CrMo4								
1.5023	38Si7								
1.5025	51Si7	50 Si 7			48 Si 7	2090			9259 H
1.5029	71Si7								
1.5085	51Mn7								
1.5094	38MnS6	38 MnS 6							
1.5131	50MnSi4								
1.5141	53MnSi4								
1.5142	60MnSi5								
1.5213	15MnV5								
1.5217	20MnV6								
1.5223	42MnV7								
1.5225	51MnV7								
1.5231	38MnSiVS5								
1.5232	27MnSiVS6								
1.5233	44MnSiVS6								
1.5403	17MnMoV64			1501-261				SBV 3	
1.5526	30MnB4								
1.5710	36NiCr6		30 NC 6	640 A 35				SNC 236	3135
1.5736	36NiCr10		30 NC 11		35 NiCr 9			SNC 631 H	3435
1.5755	31NiCr14		18 NC 13	653 M 31				SNC 836	
1.6225	11NiMn54								
1.6310	20MnMoNi55		18 MND 5						
1.6368	15NiCuMoNb5			3604-591				SBV 2	
1.6511	36CrNiMo4	36 CrNiMo 4	40 NCD 3	816 M 40	38 NiCrMo 4 KB		35 NiCrMo 4		9840
1.6582	34CrNiMo6	34 CrNiMo 6	35 NCD 6	817 M 40	35 NiCrMo 6 KB	2541	40 NiCrMo 7	SNCM 447	4340
1.6946	30CrMoNiV511								
1.6948	26NiCrMoV115								
1.6971	79Ni1								
1.6972	83Ni1								
1.7038	37CrS4	37 CrS 4						SUP 11	50 B50 H
1.7214	25CrMo4				25 CrMo 4 F				
1.7389	GX12CrMo101								
1.7561	42CrV6								
1.7701	51CrMoV4		51 CDV 4		51 CrMoV 4				
1.7707	30CrMoV9								
1.7711	40CrMoV47	40 CrMoV 4 6	42 CDV 4	1506-670-860				SNB 21-1-5	
1.7725	G530CrMoV64								
1.7733	24CrMoV55		20 CDV 6		24 CrMoV 5 5				
1.7735	14CrMoV69								
1.7741	42CrMoV73								

P 2.3 STEEL | low alloyed <1100 N/mm²

Materialnumber	Germany DIN	Europe EN	France AFNOR	Great Britain BS	Italy UNI	Sweden SIS	Spain UNE	Japan JIS	USA AISI
1.7755	GS45CrMoV104								
1.7756	GS36CrMoV104	G 36 CrMoV 10 4							
1.8070	21CrMoV511				21 CrMoV 5 11				
1.8159	50CrV4	51 CrV 4	50 CV 4	735 A 50	50 CrV 4	2230	51 CrV 4	SUP 10	6150
1.8212	21CrVMoW12								
1.8521	15CrMoV59								
1.8509	41CrAlMo7	41 CrAlMo 7	40 CAD 6. 12	905 M 39	41 CrAlMo 7	2940	41 CrAlMo 7	SACM 645	E 71400
1.8515	31CrMo12	31 CrMo 12	30 CD 12	722 M 24	31 CrMo 12	2240	31 CrMo 12		
1.8523	39CrMoV139	39 CrMoV 13 9		897 M 39	36 CrMoV 10				
1.8550	34CrAlNi7	34 CrAlMo 5							
1.8827	S460M	S 460 M	E 460	S 460 M	S460M		S460M		

P 2.4 STEEL | low alloyed <1300 N/mm²

Materialnumber	Germany DIN	Europe EN	France AFNOR	Great Britain BS	Italy UNI	Sweden SIS	Spain UNE	Japan JIS	USA AISI
1.1273	90Mn4			060 A 96				SUP 4	1090
1.2311	40CrMnMo7			BP 20	35 CrMo 8 KU				P 20
1.2710	45NiCr6								
1.2762	75CrMoNiW67								
1.5864	35NiCr18								
1.6587	17CrNiMo6	17 CrNiMo 7	18 NCD 6	820 A 16	18 NiCrMo 7	2523	14 NiCrMo 13	SNCM 815	
1.7222	42CrMoPb4								
1.7225	42CrMo4.M4S	42 CrMo 4	42 CD 4	708 A 42	42 CrMo 4	2244		SCM 440 H	4140
1.7227	42CrMoS4	42 CrMoS 4	42 CD	708 H 42	42 CrMoS 4	2244	40 CrMo 4		
1.7238	49CrMo4								

P 3.1 STEEL | high alloyed <800 N/mm²

Materialnumber	Germany DIN	Europe EN	France AFNOR	Great Britain BS	Italy UNI	Sweden SIS	Spain UNE	Japan JIS	USA AISI
1.2362	X63CrMoV51								
1.2363	X100CrMoV51	X 100 CrMoV 5 1	Z 100 CDV 5	BA 2	X 100 CrMoV 5 1 KU	2260	X 100 CrMoV 5	SKD 12	A 2
1.2367	X38CrMoV53		Z 38 CDV 5 3						
1.2376	X96CrMoV12								
1.2379	X155CrVMo121	X 153 CrMoV 12	Z 160 CDV 12	BD 2	X 155 CrVMo 12 1 KU	2310		SKD 11	D 2
1.2453	X130W5								
1.2564	X30WCrV41	30 WCrV 15 1					F.527		
1.2567	X30WCrV53	X 30 WCrV 5 3	Z 32 WCV 5		X 30 WCrV 5 3 KU			SKD 4	
1.2606	X37CrMoW51		Z 35 CWDV 5	BH 12	X 35 CrMoW 05 KU		F.537	SKD 62	H 12
1.2631	X50CrMoW911								
1.2786	X13NiCrSi3615	X 13 CrNiSi 36 15	Z 35 NCS 37-18						
1.2889	X45CoCrMoV553								

P 3.2 STEEL | high alloyed <1100 N/mm²

Materialnumber	Germany DIN	Europe EN	France AFNOR	Great Britain BS	Italy UNI	Sweden SIS	Spain UNE	Japan JIS	USA AISI
1.2083	X42Cr13	X 42 Cr 13	Z 40 C 14		X 41 Cr 13 KU	2314		SUS 420 J2	420
1.2316	X36CrMo17	X 36 CrMo 17	X38CrMo 16 1		X 38 CrMo 16 1 KU		X 38 CrMo 16		D-4
1.2343	X38CrMoVH1	X 38 CrMoV 5 1	Z 38 CDV 5	BH 11	X 37 CrMoV 5 1 KU		X 37 CrMoV 5	SKD 6	H 11
1.2344	X40CrMoV51	X 40 CrMoV 5 1	Z 40 CDV 5	BH 13	X 40 CrMoV 5 1 1 KU 2242		X 40 CrMoV 5	SKD 61	H 13
1.2436	X210CrW12	X 210 CrW 12	Z 210 CW1 2		X 215 CrW 12 1 KU	2312	X 210 CrW 12	SKD 2	
1.2581	X30WCrV93	X 30 WCrV 9 3	Z 30 WCV 9	BH 21	X 30 WCrV 9 3 KU		X 30 WCrV 9	SKD 5	H 21
1.2601	X165CrMoV12	X 165 CrMoV 12			X 165 CrMoV 12 KU	2310	X 160 CrMoV 12		
1.2622	X60WCrMoV94								
1.2678	X45CrCoVW555								H 19
1.2731	X50NiCrWV1313								
1.2764	X19NiCrMo4								
1.2767	X45NiCrMo4	40 NiCrMo 4	Y 35 NCD 16		42 NiCrMo 15 7 KU				A 9
1.2779	X6NiCrTi2615			S 66286					660
1.2787	X23CrNi17	HS 6-5-2	Z 85 WDCV 06 05 04 02	BM 2	HS 6 5 2 2	2722		SKH 9	
1.3302	S1214	HS 12 1 4			X 150 WV 1305 KU				A 7
1.3318	S1212	HS 02.01.12							
1.3401	X120Mn12	X 120 Mn 12	Z 120 M 12	BW 10	X G 120 Mn 12	2183	AM-X 120 Mn 12	SCMnH 1	A 128
1.3543	X102CrMo17	X 102 CrMo 17	X100CrMo17		X 105 CrMo 17		X 100 CrMo 17		
1.3549	X89CrMoV81								
1.3551	80MoCrV4216		80 DCV 40	T 11350	X 80 MoCrV 4 4		80 MoCrV 40-16		M 50

P 3.3 STEEL | high alloyed <1400 N/mm²

Materialnumber	Germany DIN	Europe EN	France AFNOR	Great Britain BS	Italy UNI	Sweden SIS	Spain UNE	Japan JIS	USA AISI
1.2709	X3NiCoMoTi1895								
1.2790	725NiCrMoV54								
1.2888	X20CoCrWMo109								
1.3202	S12145	HS12-1-5-5		BT 15	HS 12-1-5-5		12-1-5-5		T 15
1.3207	S104310	HS10-4-3-10	Z130WKCDV10-10-04-04	BT 42	HS 10-4-3-10		10-4-3-10	SKH 57	M 44
1.3243	S6525	HS6-5-2-5	KCV 06-05-05-04-02		HS 6-5-2-5	2723	6-5-2-5	SKH 55	M 35
1.3246	S7425	HS1-8-1	Z110 WKCDV 07-05-04	T 11341	HS 7-4-2-5		7-4-2-5		M 41
1.3247	S21018	HS2-9-1-8	Z110 DKCWV 09-08-04	BM 42	HS 2-9-1-8		2-10-1-8		M 42
1.3249	S2928			BM 34			2-9-2-8		
1.3255	S18125	HS18-1-1-4	Z80 WKCV 18-05-04-01	BT 4	HS 18-1-1-5		18-1-1-5	SKH 3	T 4
1.3257	S181215								
1.3265	S181210	HS18-0-1-10		BT 5	HS 18-0-1-10		18-0-2-10	SKH 4A	T 5
1.3342	SC652	HS6-5-2	Z90 WDCV 06-05-04-02		HSC 6-5-3				M 3
1.3343	S652	HS6-5-3	Z85 WDCV 06-05-04-02	BM 2	HS 6-5-2	2722	6-5-2	SKH 51	M2
1.3344	S653		Z120 WDCV 06-05-04-03				6-5-3	SKH 52	M 3 Cl.2
1.3346	S291	HS1-8-1	Z85 DCWV 08-04-02-01	BM 1	HS 1-8-1				M1
1.3348	S292	HS2-9-2	Z100 DCWV 09-04-02-02		HS 2-9-2	2782	2-9-2		M 7
1.3355	S1801	HS18-0-1	Z80 WCV 18-04-01	BT 1	HS 18-0-1		18-0-1	SKH 2	T 1

K 1.1 GREY CAST IRON <600 N/mm² (180 HB)

Materialnumber	Germany DIN	Europe EN	France AFNOR	Great Britain BS	Italy UNI	Sweden SIS	Spain UNE	Japan JIS	USA AISI
0.6010	GG10	GJL-100	FGL 100	Grade 100	G 10	0110-00	FG 10	FC 100	A48-20 B
0.6012	GG150 HB	GJL-HB 170							
0.6015	GG15	GJL-150	FGL 150	Grade 150	G 15	0115-00	FG 15	FC 150	A48-25 B
0.6017	GG170 HB	GJL-HB 205							

K 1.2 GREY CAST IRON <1000 N/mm² (300 HB)

Materialnumber	Germany DIN	Europe EN	France AFNOR	Great Britain BS	Italy UNI	Sweden SIS	Spain UNE	Japan JIS	USA AISI
0.6020	GG20	GJL-200	FGL 200	Grade 220	G 20	0120-00	FG 20	FC 200	A48-30 B
0.6022	GG190 HB	GJL-HB 230							
0.6025	GG25	GJL-250	FGL 250	Grade 260	G 25	0125-00	FG 25	FC 250	A48-40 B
0.6027	GG220 HB	GJL-HB 250	FGL 250						
0.6030	GG30	GJL-300	FGL 300	Grade 300	G 30	0130-00	FG 30	FC 300	A48-45 B
0.6032	GG240 HB	GJL-HB 275							
0.6035	GG35	GJL-350	FGL 350	Grade 350	G 35	0135-00	FG 35	FC 350	A48-50 B
0.6037	GG260 HB	GJL-HB 275							
0.6040	GG40	GJL-400	FGL 400	Grade 400		0140-00			A48-60 B

K 2.1 CASTINGS | MODULAR CAST IRON <650 N/mm² (200 HB)

Materialnumber	Germany DIN	Europe EN	France AFNOR	Great Britain BS	Italy UNI	Sweden SIS	Spain UNE	Japan JIS	USA AISI
0.7033	GGG353					0717-15			
0.7040	GGG40	GJS-400-15	FGS 400-12	FGS 420/12	GS 400-12	0717-02		FCD 400	60-40-18
0.7043	GGG403	GJS-400-18	FGS 370-17	FGS 370/17	GSO 42/15	0717-15		FCD 370	
0.7050	GGG50	GJS-500-7	FGS 500-7	FGS 500/7	GS 500/7	0727-02		FCD 500	65-45-12

K 2.2 CASTINGS | MODULAR CAST IRON <850 N/mm² (250 HB)

Materialnumber	Germany DIN	Europe EN	France AFNOR	Great Britain BS	Italy UNI	Sweden SIS	Spain UNE	Japan JIS	USA AISI
0.7060	GGG60	GJS-600-3	FGS 600-3	SNG 600/3	GS 600/3	0732-03		FCD 600	80-55-06
0.7070	GGG70	GJS-700-2	FGS 700-2	SNG 700/2	GS 700-2	0737-01		FCD 700	100-70-03
0.7080	GGG80	GJS-800-2	FGS 800-2	SNG 800/2	GS 800-2			FCD 800	

K 3.1 CASTINGS | MALLEABLE CAST IRON <440 N/mm² (130 HB)

Materialnumber	Germany DIN	Europe EN	France AFNOR	Great Britain BS	Italy UNI	Sweden SIS	Spain UNE	Japan JIS	USA AISI
0.8038	GTWS3818	GJMW-360-12	MB 300-12	W 38-12	W38-12	5922			
0.8040	GTW4005	GJMW-400-5	MB 400-5	W 40-05	GMB 40			FCMW 370	
0.8045	GTW4507	GJMW-450-7	MB 450-7	W 40-07	GMB 45			FCMWP 440	
0.8055	GTW55				GMB 55				
0.8065	GTW65				GMB 65				
0.8135	GTS3510	GJMB-350-10	MN 350-10	B 340/12		0815		FCMP 330	32510
0.8145	GTS4506	GJMB-450-6	MP 45-06	P 440/7		0852		FCMP 440 c3	40010

K 3.2 CASTINGS | MALLEABLE CAST IRON <800 N/mm² (230 HB)

Materialnumber	Germany DIN	Europe EN	France AFNOR	Great Britain BS	Italy UNI	Sweden SIS	Spain UNE	Japan JIS	USA AISI
0.8035	GTW3504	GJMW-350-4						FCMW 330 c1	
0.8155	GTS5504	GJMB-550-4	MP 50-5	P 510/4		0854		FCMP 490	50005
0.8165	GTS6502	GJMB-650-2	MP 60-3	P 570/3		0858		FCMP 540	70003
0.8170	GTS7002	GJMB-700-2	Mn 700-2	P 690/2	GMN 70	0862		FCMP 690	90001

M 1.1 STAINLESS STEEL | ferritic/martensitic <850 N/mm²

Materialnumber	Germany DIN	Europe EN	France AFNOR	Great Britain BS	Italy UNI	Sweden SIS	Spain UNE	Japan JIS	USA AISI
1.4000	X6Cr13	X 6 Cr 13	Z 6 C 13	403 S 17	X 6 Cr 13	2301	X 6 Cr 13	SUS 403	403
1.4002	X6CrAl13	X 6 CrAl 13	Z 6 CA 13	405 S 17	X 6 CrAl 13	2302	X 6 CrAl 13	SUS 405	405
1.4003	X2CrNi12	X2CrNi12	CLC 4003		F 12N				
1.4005	X12CrS13	X 12 CrS 13	Z 12 CF 13	416 S 21	X 12 CrS 13	2380	X12 CrS 13	SUS 416	416
1.4006	X10Cr13	X 12 Cr 13 KD	Z 12 C 13	410 S 21	X 12 Cr 13	2302	X 12 Cr 13	SUS 410	410
1.4008	GX8CrNi13	GX 7 CrNiMo 12 1	Z 12 CN 13 M	410 C 21	GX 12 Cr 13			SCS 1	414
1.4016	X6Cr17	X 8 Cr 17	Z 8 C 17	430 S 15	X 8 Cr 17 KD	2320	X 8 Cr 17	SUS 430	430
1.4017	X6CrNi171	X 6 CrNi 17 1	F 17 N		X 6 CrNi 17 1				
1.4021	X20Cr13	X 20 Cr 13	Z 20 C 13	420 S 37	X 20 Cr 13	2303	X 20 Cr 13	SUS 420 J1	420
1.4024	X15Cr13	X 15 Cr 13	Z 12 C 13 M	420 S 29	X 12 Cr 13			SUS 410 J1	
1.4027	GX20Cr14		Z 20 C 13 M	420 C 29				SCS 2	
1.4028	X30Cr13	X 30 Cr 13	Z 30 Cr 13	420 S 45	X 30 Cr 13	2304	X 30 Cr 13	SUS 420 J2	420
1.4031	X40Cr13	X 40 Cr 13	Z 40 C 14		X 40 Cr 14	2304	X 40 Cr 13	SUS 420	420
1.4034	X45Cr13	X 45 Cr 13	Z 40 C 14	420 S 45	X 40 Cr 14		X 46 Cr 13		420
1.4057	X19CrNi172	X 19 CrNi 17 2	Z 15 CN 16.02	431 S 29	X 16 CrNi 16	2321	X 15 CrNi 16	SUS 431	431
1.4059	GX22CrNi17		Z 20 CN 17.2 M	ANC 2					
1.4085	GX70Cr29								
1.4086	GX120Cr29			425 C 11					
1.4104	X12CrMoS17	X 14 CrMoS 17	Z 10 CF 17	441 S 29	X 10 CrS 17	2383	X 10 CrS 17	SUS 430 F	430 F
1.4105	X4CrMoS18	X 6 CRMoS 17	Z 6 CDF 18-02					SUS 430 F	430
1.4106	X10CrMo13								
1.4107	GX8CrNi12	GX 8 CrNi 12	GX 8 CrNi 12		GX 8 CrNi 12				
1.4108	X100CrMo13								
1.4109	X65CrMo14	X 70 CrMo 15	Z 70 CD 14					SUS 440 A	440 A
1.4110	X55CrMo14		Z 50 CD 13						
1.4111	X110CrMoV15		Z 4 CN b 17		X 6 CrNb 17			SUS 430 LX	
1.4112	X90CrMoV18	X 90 CrMoV 18	Z 3 CT 1 2	409 S 1 9	X 6 CrTi 1 2			SUS 440 B	440 B
1.4113	X6CrMo171	X 8 CrMo 17	Z 8 CD 17.02	434 S 17	X 8 CrMo 17	2325		SUS 434	434
1.4115	X20CrMo171								
1.4116	X45CrMoV15	X 50 CrMoV 15	Z 50 CD 15		X50 CrMoV 15		X 46 CrMo 16		
1.4117	X38CrMoV15								
1.4119	X15CrMo13								
1.4120	X20CrMo13		Z 20 CD 14						
1.4122	X35CrMo17	X 39 CrMo 17 1	X39CrMo17-1		X 35 CrMo 17				
1.4123	X15TN								
1.4125	X105CrMo17	X 105 CrMo 17	Z 100 CD 17		X 105 CrMo 17			SUS 440 C	440 C
1.4136	GX70CrMo292		Z 60 CD 29.2 M						
1.4138	GX120CrMo292								
1.4313	X5CrNi134	X 3 CrNiMo 13 4	Z 4 CDN 13.4	425 C 11	X 3 CrNiMo 13 4	2385		SCS 5	CA 6-NM
1.4317	GX4CrNi134	GX 4 CrNi 13 4	GX 4 CrNi 13 4		GX 4 CrNi 13 4				
1.4351	X3CrNi134	X 3 CrNi 14 04 KE							
1.4405	GX5CrNiMo165	GX 4 CrNiMo 16 5 1	GX 4 CrNiMo 16 5 1		GX 4 CrNiMo 16 5 1				
1.4502	X8CrTi18	X 6 Cr 18 KE							
1.4510	X6CrTi17	X 8 CrTi 17	Z 8 CT 17		X 6 CrTi 17		X 8 CrTi 17	SUS 430 LX	430 Ti
1.4511	X6CrNb17	X 3 CrNb 17	Z 8 CNb 17		X 6 CrNb 17			SUS 430 LX	430 Nb
1.4512	X6CrTi12	X 5 CrTi 12	Z 6 CT 12	409 S 19	X 6 CrTi12			SUH 409	409

M 1.1 STAINLESS STEEL | ferritic/martensitic <850 N/mm²

Materialnumber	Germany DIN	Europe EN	France AFNOR	Great Britain BS	Italy UNI	Sweden SIS	Spain UNE	Japan JIS	USA AISI
1.4523	X8CrMoTi17	X 2 CrMoTiS 18 2	X 2 CrMoTiS 18 2						
1.4528	X105CrCoMo182								
1.4535	X90CrCoMoV17								
1.4543	X3CrNiCuTi129				X 6 CrNiNB 18 11				
1.4704	X45SiCr4	45SiCr16-11							HNV 2
1.4710	GX30CrSi6	GX 30 CrSi 6							
1.4712	X10CrSi6		K 51255						
1.4713	X10CrAlSi7	X 10 CrAlSi 7							
1.4718	X45CrSi93	X 45 CrSi 8	Z 45 CS 9	401 S 45	X 45 CrSi 8		F.3220	SUH 1	HNV 3
1.4722	X10CrSi13						X 10 CrSi 13		
1.4724	X10CrAl13	X 10 CrAl 13	Z 10 C 13	BH 12	X 10 CrAl 12		X 10 CrAl 13	SUS 405	H-12
1.4725	X8CrAl144	CrAl 14 4	K 91670						
1.4729	GX40CrSi13				GX 35 Cr 13			SCH 1	
1.4740	GX40CrSi17				GX 35 Cr 17				
1.4742	X10CrAl18		Z 10 CAS 18	403 S 15	X 8 Cr 17		X 10 CrAl 18	SUH 21	430
1.4745	GX40CrSi23								
1.4747	X80CrNiSi20	X 80 CrNiSi 20	Z 80 CSN 20.02	433 S 65	X 80 CrSiNi 20		X 80 CrSiNi20-02	SUH 4	HNV 6
1.4762	X10CrAl24	X 10 CrAl 24	Z 10 CAS 24		X 16 Cr 26	2322	X 10 CrAl 24	SUH 442	446
1.4767	X8CrAl205	CrAl 20 5							
1.4773	X8Cr30								
1.4776	GX40CrSi29			452 C 11	GX 35 Cr 28			SCH 2	

M 2.1 STAINLESS STEEL | austenitic <650 N/mm²

Materialnumber	Germany DIN	Europe EN	France AFNOR	Great Britain BS	Italy UNI	Sweden SIS	Spain UNE	Japan JIS	USA AISI
1.4300	X12CrNi188			302					
1.4301	X5CrNi1810	X 6 CrNi 18 10 KD	Z 6 CN 18.09	304 S 15	X 5 CrNi 18 10	2332	X 5 CrNi 18 11	SUS 304	304 H
1.4302	X5CrNi199	X 6 CrNi 20 10 KE		308 S 96					
1.4303	X5CrNi1812	X 8 CrNi 18 12 KD	Z 8 CN 17.07	305 S 19	X 8 CrNi 19 10		X 8 CrNi 18 12	SUS 305	308
1.4305	X10CrNiS189	X 8 CrNiS 19 9	Z 8 CNF 18.09	303 S 31	X 8 CrNiS 18 9	2346	F.310.C	SUS 303	303
1.4307	X2CrNi189	X 2 CrNi 18 9	CLC 18.9.L	304 S 11	X 2 CrNi 18 9			SUS 304 L	304 L
1.4308	GX6CrNi189	X 2 CrNi 18 7	Z 6 CN 18.10 M	304 C 15	GX 5 CrNi 19 10	2333		SCS 13	CF-8
1.4310	X12CrNi177	X 12 CrNi 17 7	Z 12 CN 17.07	301 S 21	X 12 CrNi 17 07		X 12 CrNi 17 07	SUS 301	301
1.4311	X2CrNi1810	X 2 CrNiN 18 10	Z 8 CN 18.12	304 S 62	X 8 CrNi 19 10	2371	X 8 CrNi 18 12	SUS 304 LN	304 LN
1.4312	GX10CrNi188		Z 10 CN 18.9 M	302 C 25				SCS 12	
1.4318	X 2 CrNiN 18 7	X 2 CrNiN 18 7	18-7L		18-7L				
1.4319	X3CrNi178			302 S 26	X 10 CrNi 18 09			SUS 302	
1.4350	X5CrNi189		Z 6 CN 18.09	304 S 31	X 5 CrNi 18 10				304
1.4401	X5CrNiMo17122	X 6 CrNiMo 17 12 2 KD	Z 6 CND 17.11	316 S 16	X 5 CrNiMo 17 12	2347	X 5 CrNiMo 17 12	SUS 316	316
1.4404	X2CrNiMo17132	GX 3 CrNiMo 17 12 2 KD	Z 3 CND 19.10 M	316 S 12	GX 2 CrNiMo 19 11	2348	X 2 CrNiMo	SUS 316 L	316 L
1.4406	X2CrNiMoN17122	X 3 CrNiMoN 17 12 2	Z 2 CND 17.12 Az	316 S 61	X 2 CrNiMoN 17 12			SUS 316 LN	316 LN
1.4407	GX 5 CrNiMo 13 4	GX 5 CrNiMo 13 4	J 91550						A757
1.4408	GX6CrNiMo1810	GX 5 CrNiMo 19 11 2	GX 5 CrNiMo 19 11 2 316 C 16		GX 5 CrNiMo 19 11 2	2343	X 7 CrNiMo 20 10	SCS 14	CF-8M
1.4435	X2CrNiMo18143	X 2 CrNiMo 18 16	Z 2 CDN 17.13	316 S 11	X 2 CrNiMo 17 13	2353		SUS 16	316 L
1.4436	X5CrNiMo17133	X 6 CrNiMo 18 13 3 KD	Z 6 CND 17.12	316 S 16	X 5 CrNiMo 17 13	2343	X 6 CrNiMo 17 12 03	SUS 316	316
1.4438	X2CrNiMo18164	X 3 CrNiMo 18 16 4	Z 2 CND 19.15	317 S 12	X 2 CrNiMo 18 15	2367		SUS 317 L	317 L
1.4440	X2CrNiMo18165								
1.4442	X2CrNiMo18154		X 3 CrNiMoN 18 14						

M 2.2 STAINLESS STEEL | austenitic <750 N/mm²

Materialnumber	Germany DIN	Europe EN	France AFNOR	Great Britain BS	Italy UNI	Sweden SIS	Spain UNE	Japan JIS	USA AISI
1.4429	X2CrNiMoN17133	X 3 CrNiMoN 17 12 2	Z 2 CND 17.13 Az	316 S 62	X 2 CrNiMoN 17 13	2375		SUS 316 LN	316 LN
1.4432	X2CrNiMo17123	X 2 CrNiMo 17 12 2	Z 3 CND 17 13 30	316 S 13	X 2 CrNiMo 17 12 3			SUS 316L	316 L
1.4434	X2CrNiMoN18124		CLC 18.12.4.LN		X 2 CrNiMoN 18 12 4				317 LN
1.4439	X2CrNiMoN17135	X 3 CrNiMo 17 13 5	Z 3 CnD 18.14-05 Az						
1.4465	X1CrNiMoN25252								
1.4505	X5NiCrMoCuNb2018								
1.4506	X5NiCrMoCuTi2018								
1.4529	X1NiCrMoCuN25206								
1.4536	GX2NiCrMoCuN2520	GX 2 CrNiMoCuN 25 20 6							
1.4539	X1NiCrMoCuN25205	X 1 NiCrMoCu 25 20 5	Z 1 NCDU 25.20	904 S 13		2662			
1.4541	X6CrNiTi1810	X 6 CrNiTi 18 10	Z 6 CNT 18.10	321 S 12	X 6 CrNiTi 18 11	2337	X 7 CrNiTi 18 11	SUS 321	321
1.4542	X5CrNiCuNb164	X 5 CrNiCuNb 16 4	Z 7 CNU 17.04		X 5 CrNiCuNb 16 4			SUS 630	630
1.4550	X6CrNiNb1810	X 6 CrNiNb 18 10	Z 6 CNNb 18.10	347 S 17	X 6 CrNiNb 18 11	2338	X 6 CrNiNb 18 11	SUS 347	347
1.4551	X5CrNiNb199	X 5 CrNiNb 20 10 KE	Z 6 CNNb 20-10					SUS 347 Y	
1.4552	GX5CrNiNb189	GX 5 CrNiNb 19 11	Z 4 CNNb 19.10 M	347 C 17	GX 5 CrNiNb 19 11			SCS 21	
1.4571	X6CrNiMoTi17122	X 6 CrNiMoTi 17 12 2	Z 6 CNDT 17.12	320 S 31	X 6 CrNiMoTi 17 12	2350	X 6 CrNiMoTi 17 12 03	SUS 316 Ti	316 Ti
1.4573	X10CrNiMoTi812			320 S 33	X 6 CrNiMoTi 17 13			SUS 316 Ti	316 Ti
1.4575	X2CrNiMoNb2842								
1.4577	X3CrNiMoTi2525								
1.4580	X6CrNiMoNb17122	X 6 CrNiMoNb 17 12 2	Z 6 CNDNb 17.12	318 S 17	X 6 CrNiMo 17 12 2				316 Cb
1.4581	GX5CrNiMoNb1810	GX 5 CrNiMoNb 19 11 2	Z 4 CNDNb 18.12 M	318 C 17	GX 6 CrNiMoNb 20 11			SCS 22	
1.4582	X4CrNiMoNb257							SCS 22	
1.4583	X10CrNiMoNb1812				X 6 CrNiMoNb 17 13				318
1.4585	GX7CrNiMoNb257								
1.4586	X5CrNiMoCuNb2218								
1.4821	X20CrNiSi254	X 20 CrNiSi 25 4	Z 20 CNS 25.04			2322			
1.4822	GX40CrNi245		J 92605	J 92605					
1.4823	GX40CrNiSi274								
1.4825	GX25CrNiSi189			302 C 35	GX 16 CrNi 20 10				
1.4826	GX40CrNiSi229							SCH 12	
1.4828	X15CrNiSi2012	X 15 CrNiSi 20 12	Z 15 CNS 20.12	309 S 24	X 16 CrNiSi 20 12		X 15 CrNiSi 20 12	SUH 309	309
1.4833	X7CrNi2314	X 12 CrNi 23 13	Z 15 CN 24.13	309 S 24	X 6 Cni 23 14			SUS 309 S	309 S
1.4837	GX40CrNiSi2512			309 C 30	GX 35 CrNi 25 12			SCS 17	
1.4841	X15CrNiSi2520	X 15 CrNiSi 25 20	Z 15 CNS 25.20	314 S 25	X 16 CrNiSi 25 20		X 15 CrNiSi 25 20	SUH 310	310
1.4845	X12CrNi2521	X 8 CrNi 25 21	Z 12 CN 25.20	310 S 24	X 6 CrNi 25 20	2361	F.331	SUS 310 S	310 S
1.4848	GX40CrNiSi2520			310 C 40	GX 40 CrNi 26 20		X 40 CrNi 25 20	SCH 21	HK
1.4861	X10NiCr3220								
1.4866	X33CrNiMnN238	X 33 CrNiMnN 23 8	X 33 CrNiMnN 23 8						
1.4871	X53CrMnNiN219		Z 52 CMN 21.09	349 S 54	X 53 CrMnNiN 21 9		X 53 CrMnNiN 21-09	SUH 35	EV 8
1.4873	X45CrNiW189	X 45 CrNiW 18 9	Z 35 CNWS 14.14	331 S 40	X 45 CrNiW 18 9		X 45 CrNiSiW 18-09	SUH 31	
1.4878	X12CrNiTi189	X 10 CrNiTi 18 10	Z 6 CNT 18.12	321 S 20	X 6 CrNiTi 18.11	2337	X 6 CrNiTi 18 11	SUS 321	321
1.4881	X70CrMnNiN216				X 70 CrMnNiN 21 6				EV 11
1.4882	X50CrMnNiNbN219	X 50 CrMnNiNbN 21 9	Z 50 CMNNb 21.09						
1.4919	X6CrNiMo1713	X 6 CrNiMo 17 12 2	Z 6 CND 17.13 B	316 S 51					316 H
1.4948	X6CrNi1811	X 6 CrNi 18 10	Z 6 CN 18.09	304 S 51	X 5 CrNi 18 10 KW	2333			
1.4949	X3CrNi1811				X 2 CrNiN 18 11				
1.4961	X8CrNiNb1613			347 S 51			X 7 CrNiNb 16 13		
1.4981	X8CrNiMoNb1616						X 7 CrNiMo 16 16		

M 3.1 **DUPLEX STEEL | SUPER AUSTENITIC** | super austenitic <1100 N/mm²

Materialnumber	Germany DIN	Europe EN	France AFNOR	Great Britain BS	Italy UNI	Sweden SIS	Spain UNE	Japan JIS	USA AISI
1.4162	X2CrMnNiN2252	X 2 CrMnNiN 22 5 2			X2CrMnNiN21-5-1		S32101	LDX 2101	S321 01
1.4362	X2CrNiN234	X 2 CrNiN 23 4	Z 3 CN 23 04 AZ			2327			S323 04
1.4410	X2CrNiMoN2574	X 2 CrNiMoN 25 7 4	Z 5 CND 20.10 M		X 2 CrNiMoN 25 7 4			SCS 14 A	S327 50
1.4460	X4CrNiMo2752	X 3 CrNiMo 27 5 2	X 2 CrNiMo 25 7 3		X 3 CrNiMo 27 5 2	2324	X 8 CrNiMo 27 05	SUS 329 J1	S325 50
1.4462	X2CrNiMoN2253	X 2 CrNiMoN 22 5 3	Z 3 CND 22.05 AZ	318 S 13	X 2 CrNiMoN 22 5 3	2377		SUS 329 J3L	S318 03
1.4465	X1CrNiMoN25252	X 1 CrNiMoN 25 25 2	Z 1 CND 25.22 AZ						S310 50
1.4501	X2CrNiMoCuWN2574	X 2 CrNiMoCuWN 25 7 4	Z 3 CND 25.06 AZ					SM 25 Cr	S327 60
1.4507	X2CrNiMoCuN2563	X 2 CrNiMoCuN 25 6 3	Z 3 CNDU 25.06 AZ					QSA 2505	S325 20
1.4534	13-8 PH	X 3 CrNiMoAl 13 8 2	Z 4 CNDAT 13.09						S138 00
1.4542	17-4 PH	X 5 CrNiCuNb 16 4	Z 7 CNU 17 04					SUS 630	630
1.4545	15-5 PH	X 5 CrNiCu 15 5	Z 6 CNU 15 05						XM-12
1.4548	17-4 PH	X5CrNiCuNb1744	X 5 CrNiCuNb 16 4					SUS 630	S174 00
1.4568	17-7 PH	X 7 CrNiAl 17 7	Z 9 CNA 17 07	301 S 81	X 7 CrNiAl 17 7	2388	X 7 CrNiAl 17 7	SUS 631	S177 00

Technical formulas

Calculate cutting speed (m/min)

$$V_c = \frac{D \cdot \pi \cdot n}{1000}$$

Calculate rotational speed (rpm)

$$n = \frac{V_c \cdot 1000}{D \cdot \pi}$$

Calculate feed rate (mm/min)

$$V_f = n \cdot z \cdot f_z$$

Calculate feed per tooth (mm/number of teeth)

$$f_z = \frac{V_f}{n \cdot z}$$

Calculate chip removal rate (cm³/min)

$$Q = \frac{a_p \cdot a_e \cdot V_f}{1000}$$

Calculate average chip thickness (mm)

$$h_m = f_z \cdot \frac{\sqrt{a_e}}{D}$$

Explanation of terms

V_c	Cutting speed	in m/min
n	Rotational speed	in rpm
V_f	Feed rate	in mm/min
F_z	Feed per tooth	in mm/number of teeth
z	Number of teeth (cutting)	
a_p	Depth of cut	in mm
a_e	Width of cut	in mm
h_m	Average chip thickness	in mm
Q	Chip removal rate	in cm ³ /min
D	Diameter of tool	in mm

EXPLANATION OF CUTTING DATA

EXAMPLE FOR SIDE MILLING OF 1.3561 WITH Ø10:

P 2.3 STEEL | low alloyed <1100 N/mm²

Materialnumber	Germany DIN	Europe EN	France AFNOR	Great Britain BS	Italy UNI	Sweden SIS	Spain UNE	Japan JIS	USA AISI
1.2419	105WCr6	105 WCr 5	105 WC 13		107 WcR 5 KU	2140	105 WCr 5	SKS 31	
1.2511	80WCrV3								
1.2515	100WV4							SKS 21	
1.3561	44Cr2	46 Cr 1 KD	44 Cr 2						5046
1.3563	43CrMo4		43 CrMo 4						4142

THE MATERIAL KEY WITH DETAILED BREAKDOWN OF MATERIALS BY MATERIAL GROUP CAN BE FOUND AT THE END OF THE CATALOGUE.

P	Material	Strength (N/mm ²)	Side Milling	Finishing	ETC	Materialgroup Factor fz / a	Materialgroup Factor ae ETC
			Vc = m/min	Vc = m/min	Vc = m/min		
1.1	unalloyed	<500	240	260	380	1	1
1.2-1.5	unalloyed	<1100	200	220	316	0.9	0.8
2.1-2.2	low-alloyed	<950	190	210	290	0.9	0.8
2.3-2.4	low-alloyed	<1300	160	180	203	0.8	0.75
3.1-3.2	high-alloyed	<1100	180	190	220	0.8	0.7
3.3	high-alloyed	<1400	150	160	196	0.7	0.68
K	CASTINGS		Vc = m/min	Vc = m/min	Vc = m/min		
1.1-1.2	Grey cast iron	<1000	220	230	262	0.9	0.8
2.1-2.2	Modular cast iron	<850	180	190	208	0.8	0.75
3.1-3.2	Malleable cast iron	<800	160	170	193	0.8	0.75
M	STAINLESS STEEL		Vc = m/min	Vc = m/min	Vc = m/min		
1.1	ferritic/martensitic	<850	90	95	172	0.9	0.6
2.1	austenitic	<650	75	80	146	0.8	0.45
2.2	austenitic	<750	70	75	128	0.75	0.4
3.1	DUPLIX STEEL super austenitic	<1100					

OVERVIEW OF THE DIFFERENT MATERIAL GROUPS FOR THIS TOOL INCLUDING FACTORS

Material P 1.1

D1	L2	Immersion Angle	Side Milling			Finishing			ETC			
			fz (mm/Z)	ae = 0.3xD (mm)	ap (mm)	fz (mm/Z)	ae (mm)	ap (mm)	fz (mm/Z)	ae (mm)	ap (mm)	hmax (mm)
6	13	1°	0.045	1.8	L2max	0.02	0.2	L2max	0.072	1.3	L2max	0.0593
8	19	1°	0.06	2.4	L2max	0.025	0.2	L2max	0.096	1.5	L2max	0.0749
10	22	1.2°	0.07	3	L2max	0.03	0.2	L2max	0.112	1.8	L2max	0.0861
12	26	1.2°	0.08	3.6	L2max	0.035	0.2	L2max	0.136	2.1	L2max	0.1034
16	32	1.5°	0.09	4.8	L2max	0.04	0.2	L2max	0.152	2.6	L2max	0.1121
20	41	2°	0.11	6	L2max	0.045	0.2	L2max	0.176	2.9	L2max	0.1239

ALL DATA GIVEN HERE IS FOR THE FIRST GROUP P1.1 IN THE MATERIAL GROUP OVERVIEW

DETERMINATION OF CUTTING DATA:

From the material key results: **material group P2.3**

Vc= 160 m/min (as indicated in the table)

fz= 0.07 mm/Z (as indicated in the table) x Factor fz 0.8 = fz **0.056 mm/Z**



VIDEO EXPLANATION

EXAMPLE FOR ETC OF 1.3207 WITH Ø10:

P 3.3 STEEL | high alloyed <1400 N/mm²

Materialnumber	Germany DIN	Europe EN	France AFNOR	Great Britain BS	Italy UNI	Sweden SIS	Spain UNE	Japan JIS	USA AISI
1.2709	X3NiCoMoTi1895								
1.2790	72SiNiCrMoV54								
1.2888	X20CoCrWMo109								
1.3202	S12145	HS12-1-5-5		BT 15	HS 12-1-5-5		12-1-5-5		T 15
1.3207	S104310	HS10-4-3-10	Z130WKCDV10-10-04-04	BT 42	HS 10-4-3-10		10-4-3-10	SKH 57	M 44

THE MATERIAL KEY WITH DETAILED BREAKDOWN OF MATERIALS BY MATERIAL GROUP CAN BE FOUND AT THE END OF THE CATALOGUE.

P	Material	Strength (N/mm ²)	Side Milling	Finishing	ETC	Materialgroup Factor fz / a	Materialgroup Factor ae ETC
			Vc = m/min	Vc = m/min	Vc = m/min		
STEEL							
1.1	unalloyed	<500	240	260	380	1	1
1.2-1.5	unalloyed	<1100	200	220	316	0.9	0.8
2.1-2.2	low-alloyed	<950	190	210	290	0.9	0.8
2.3-2.4	low-alloyed	<1300	160	180	203	0.8	0.75
3.1-3.2	high-alloyed	<1100	180	190	220	0.8	0.7
3.3	high-alloyed	<1400	150	160	196	0.7	0.68
CASTINGS							
1.1-1.2	Grey cast iron	<1000	220	230	262	0.9	0.8
2.1-2.2	Modular cast iron	<850	180	190	208	0.8	0.75
3.1-3.2	Malleable cast iron	<800	160	170	193	0.8	0.75
STAINLESS STEEL							
1.1	ferritic/martensitic	<850	90	95	172	0.9	0.6
2.1	austenitic	<650	75	80	146	0.8	0.45
2.2	austenitic	<750	70	75	128	0.75	0.4
3.1	DUPLIX STEEL super austenitic	<1100					

OVERVIEW OF THE DIFFERENT MATERIAL GROUPS FOR THIS TOOL INCLUDING FACTORS

Material P 1.1

D1	L2	Immersion Angle	Side Milling			Finishing			ETC			
			fz (mm/Z)	ae = 0.3xD (mm)	ap (mm)	fz (mm/Z)	ae (mm)	ap (mm)	fz (mm/Z)	ae (mm)	ap (mm)	hmax (mm)
6	13	1°	0.045	1.8	L2max	0.02	0.2	L2max	0.072	1.3	L2max	0.0593
8	19	1°	0.06	2.4	L2max	0.025	0.2	L2max	0.096	1.5	L2max	0.0749
10	22	1.2°	0.07	3	L2max	0.03	0.2	L2max	0.112	1.8	L2max	0.0861
12	26	1.2°	0.08	3.6	L2max	0.035	0.2	L2max	0.136	2.1	L2max	0.1034
16	32	1.5°	0.09	4.8	L2max	0.04	0.2	L2max	0.152	2.6	L2max	0.1121
20	41	2°	0.11	6	L2max	0.045	0.2	L2max	0.176	2.9	L2max	0.1239

ALL DATA GIVEN HERE IS FOR THE FIRST GROUP P1.1 IN THE MATERIAL GROUP OVERVIEW

DETERMINATION OF CUTTING DATA:

From the material key results: **material group P3.3**

Vc= 196 m/min (as indicated in the table)

fz= 0.112 mm/Z (as indicated in the table) x Factor fz 0.7 = **fz 0.0784 mm/Z**

ae= 1.8 mm (as indicated in the table) x Factor ae 0.68 = **1.224 mm ae**