

Kühlung	
Toleranz	d04
Beschichtung	AlphaDura Navy

Strategie	HSC	HPC	
Anwendung			
Eigenschaften	HA		R

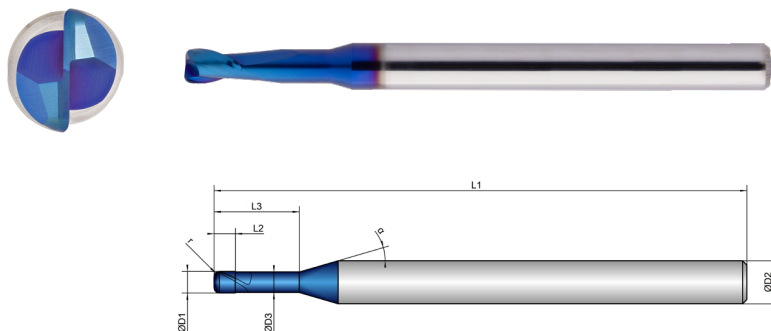

- Zum Fräsen von gehärteten Stählen entwickeltes Ultrafeinkornsubstrat
 - Optimierte Stirn für lange Standzeit und höchste Formgenauigkeit
 - Verstärkter Kern zum Fräsen bis 70 HRC
-
- Abzeilen von 3D-Konturen
-
- Toleranz D1: -0,001/-0,006 mm
 - Toleranz D3: 0/-0,02 mm
 - Radiustoleranz r: 0/-0,003 mm (gemessen von 0-90°)





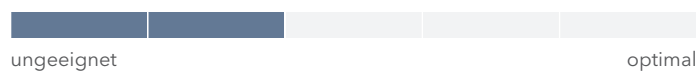







Schuppen



Schichten



	D1	D3	L2	L3	L1	D2	z	r		α
K202112	 mm \varnothing	 mm \varnothing	 mm	 mm	 mm	 mm \varnothing	 #	 mm	 °	 °
1,5X4	1,5	1,44	1,5	4,0	50,0	4,0	2	0,50	30	16
1,5X6	1,5	1,44	1,5	6,0	50,0	4,0	2	0,50	30	16
1,5X8	1,5	1,44	1,5	8,0	50,0	4,0	2	0,50	30	16
1,5X10	1,5	1,44	1,5	10,0	50,0	4,0	2	0,50	30	16
1,5X12	1,5	1,44	1,5	12,0	54,0	4,0	2	0,50	30	16
1,5X16	1,5	1,44	1,5	16,0	54,0	4,0	2	0,50	30	16
1,5X20	1,5	1,44	1,5	20,0	60,0	4,0	2	0,50	30	16
2X4	2,0	1,91	2,0	4,0	50,0	4,0	2	0,50	30	16
2X6	2,0	1,91	2,0	6,0	50,0	4,0	2	0,50	30	16
2X8	2,0	1,91	2,0	8,0	50,0	4,0	2	0,50	30	16
2X10	2,0	1,91	2,0	10,0	50,0	4,0	2	0,50	30	16







K202112	 mm ∅	 mm ∅	 mm	 mm	 mm	 mm ∅	 #	 mm	 °	 °
2X12	2,0	1,91	2,0	12,0	54,0	4,0	2	0,50	30	16
2X16	2,0	1,91	2,0	16,0	54,0	4,0	2	0,50	30	16
2X20	2,0	1,91	2,0	20,0	60,0	4,0	2	0,50	30	16
2X26	2,0	1,91	2,0	26,0	70,0	4,0	2	0,50	30	16
2,5X10	2,5	2,41	2,5	10,0	50,0	4,0	2	0,50	30	16
2,5X12	2,5	2,41	2,5	12,0	60,0	4,0	2	0,50	30	16
2,5X30	2,5	2,41	2,5	30,0	70,0	4,0	2	0,50	30	16
3X10	3,0	2,91	4,5	10,0	50,0	4,0	2	0,50	30	16
3X12	3,0	2,91	4,5	12,0	50,0	4,0	2	0,50	30	16
3X30	3,0	2,91	4,5	30,0	70,0	4,0	2	0,50	30	16

Material	Hardness in HRC	Dimension	Infeed in mm	Application	Ø1,5x4			Ø1,5x20			Ø2x4			Ø2x26		
					ae=1xD	ae=0,1xD	ae=0,1xD	ae=1xD	ae=0,04xD	ae=0,04xD	ae=1xD	ae=0,1xD	ae=0,1xD	ae=1xD	ae=0,05xD	ae=0,05xD
					ap=0,05xD	ap=L2 max	ap=0,1xD	ap=0,02xD	ap=L2 max	ap=0,04xD	ap=0,05xD	ap=L2 max	ap=0,1xD	ap=0,03xD	ap=L2 max	ap=0,05xD
			Feed (mm/Z)	fz	fz	fz	fz	fz	fz	fz	fz	fz	fz	fz	fz	fz
H HARDENED STEEL																
			Vc (m/min)													
1.1	46-55		110	0,017	0,022	0,024	0,01	0,015	0,017	0,025	0,03	0,032	0,02	0,025	0,027	
1.2	56-60		70	0,016	0,021	0,022	0,009	0,014	0,016	0,023	0,028	0,03	0,019	0,024	0,026	
1.3	60-65		50	0,014	0,019	0,02	0,007	0,012	0,014	0,021	0,026	0,028	0,018	0,023	0,025	
1.4	66-70		40	0,013	0,018	0,019	0,006	0,011	0,013	0,019	0,025	0,027	0,017	0,022	0,024	
M STAINLESS STEEL																
			Vc (m/min)													
1.1	ferritic/martensitic	<850	90	0,018	0,023	0,025	0,011	0,016	0,018	0,026	0,031	0,033	0,021	0,026	0,028	
2.1	austenitic	<650	75	0,017	0,022	0,024	0,01	0,015	0,017	0,024	0,029	0,031	0,019	0,025	0,027	
2.2	austenitic	<750	70	0,015	0,02	0,022	0,008	0,013	0,015	0,022	0,027	0,029	0,017	0,024	0,026	
3.1	DUPLEX STEEL super austenitic	<1100	50	0,014	0,019	0,021	0,007	0,012	0,014	0,02	0,025	0,027	0,015	0,023	0,025	
N COPPER																
			Vc (m/min)													
	Tungsten Copper (WCu)	<700	110	0,018	0,023	0,025	0,011	0,016	0,018	0,026	0,031	0,033	0,021	0,026	0,028	
P STEEL																
			Vc (m/min)													
1.1	unalloyed	<500	190	0,022	0,027	0,029	0,015	0,02	0,022	0,03	0,037	0,039	0,025	0,032	0,034	
1.2-1.5	unalloyed	<1100	180	0,022	0,027	0,029	0,015	0,02	0,022	0,03	0,037	0,039	0,025	0,032	0,034	
2.1-2.2	low-alloyed	<950	170	0,02	0,025	0,027	0,013	0,018	0,02	0,028	0,035	0,037	0,023	0,03	0,032	
2.3-2.4	low-alloyed	<1300	150	0,02	0,025	0,027	0,013	0,018	0,02	0,028	0,035	0,037	0,023	0,03	0,032	
3.1-3.2	high-alloyed	<1100	150	0,018	0,023	0,025	0,011	0,016	0,018	0,026	0,032	0,034	0,021	0,027	0,029	
3.3	high-alloyed	<1400	130	0,017	0,022	0,024	0,01	0,015	0,017	0,025	0,03	0,032	0,02	0,025	0,027	
K CASTINGS																
			Vc (m/min)													
1.1-1.2	Grey cast iron	<1000	190	0,022	0,027	0,029	0,015	0,02	0,022	0,03	0,037	0,039	0,025	0,032	0,034	
2.1-2.2	Modular cast iron	<850	180	0,02	0,025	0,027	0,013	0,018	0,02	0,028	0,035	0,037	0,023	0,03	0,032	
3.1-3.2	Malleable cast iron	<800	170	0,02	0,025	0,027	0,013	0,018	0,02	0,028	0,035	0,037	0,023	0,03	0,032	
HINWEIS Die in Türkis markierten Werte sind Nebenanwendungen!																
Die Werte in der Tabelle sind die kürzeste und die längste Freistichlänge (L3) jeder Abmessung; bitte berechnen Sie fz, ap und ae in Abhängigkeit von den angegebenen Werten. ae/ap(max)=0,5x Eckenradius!																

Material	Hardness in HRC	Dimension	Ø2,5x10			Ø2,5x30			Ø3x10			Ø3x30			
			Infeed in mm			Infeed in mm			Infeed in mm			Infeed in mm			
			ae=1xD	ae=0,1xD	ae=0,1xD	ae=1xD	ae=0,04xD	ae=0,04xD	ae=1xD	ae=0,1xD	ae=0,1xD	ae=1xD	ae=0,05xD	ae=0,05xD	
			ap=0,05xD	ap=L2 max	ap=0,1xD	ap=0,02xD	ap=L2 max	ap=0,04xD	ap=0,05xD	ap=L2 max	ap=0,1xD	ap=0,03xD	ap=L2 max	ap=0,05xD	
			Application			Application			Application			Application			
			Feed (mm/Z)			Feed (mm/Z)			Feed (mm/Z)			Feed (mm/Z)			
			fz	fz	fz	fz	fz	fz	fz	fz	fz	fz	fz	fz	
			Vc (m/min)			Vc (m/min)			Vc (m/min)			Vc (m/min)			
H	HARDENED STEEL														
1.1		46-55	110	0,025	0,03	0,032	0,02	0,025	0,027	0,027	0,032	0,034	0,017	0,022	0,024
1.2		56-60	70	0,023	0,028	0,03	0,019	0,024	0,026	0,025	0,03	0,032	0,015	0,02	0,022
1.3		60-65	50	0,021	0,026	0,028	0,018	0,023	0,025	0,023	0,028	0,03	0,013	0,018	0,02
1.4		66-70	40	0,019	0,025	0,027	0,017	0,022	0,024	0,021	0,026	0,028	0,011	0,016	0,018
			Feed (mm/Z)			Feed (mm/Z)			Feed (mm/Z)			Feed (mm/Z)			
			fz	fz	fz	fz	fz	fz	fz	fz	fz	fz	fz	fz	
			Vc (m/min)			Vc (m/min)			Vc (m/min)			Vc (m/min)			
M	STAINLESS STEEL														
1.1	ferritic/martensitic	<850	90	0,026	0,031	0,033	0,021	0,026	0,028	0,028	0,033	0,034	0,018	0,023	0,025
2.1	austenitic	<650	75	0,024	0,029	0,031	0,019	0,024	0,026	0,026	0,031	0,033	0,016	0,021	0,023
2.2	austenitic	<750	70	0,022	0,027	0,029	0,017	0,022	0,024	0,024	0,029	0,031	0,014	0,019	0,021
3.1	DUPLEX STEEL super austenitic	<1100	50	0,02	0,026	0,028	0,016	0,02	0,022	0,022	0,027	0,029	0,012	0,017	0,019
N	COPPER														
	Tungsten Copper (WCu)	<700	110	0,026	0,031	0,033	0,021	0,026	0,028	0,028	0,033	0,034	0,018	0,023	0,025
			Vc (m/min)			Vc (m/min)			Vc (m/min)			Vc (m/min)			
P	STEEL														
1.1	unalloyed	<500	190	0,03	0,036	0,038	0,025	0,031	0,033	0,032	0,038	0,04	0,022	0,028	0,03
1.2-1.5	unalloyed	<1100	180	0,03	0,036	0,038	0,025	0,031	0,033	0,032	0,038	0,04	0,022	0,028	0,03
2.1-2.2	low-alloyed	<950	170	0,028	0,034	0,036	0,023	0,029	0,031	0,03	0,036	0,038	0,02	0,026	0,028
2.3-2.4	low-alloyed	<1300	150	0,028	0,034	0,036	0,023	0,029	0,031	0,03	0,036	0,038	0,02	0,026	0,028
3.1-3.2	high-alloyed	<1100	150	0,026	0,031	0,033	0,021	0,026	0,028	0,028	0,033	0,035	0,018	0,023	0,025
3.3	high-alloyed	<1400	130	0,025	0,03	0,032	0,02	0,025	0,027	0,027	0,032	0,034	0,017	0,022	0,024
			Vc (m/min)			Vc (m/min)			Vc (m/min)			Vc (m/min)			
K	CASTINGS														
1.1-1.2	Grey cast iron	<1000	190	0,03	0,036	0,038	0,025	0,031	0,033	0,032	0,038	0,04	0,022	0,028	0,03
2.1-2.2	Modular cast iron	<850	180	0,028	0,034	0,036	0,023	0,029	0,031	0,03	0,036	0,038	0,02	0,028	0,028
3.1-3.2	Malleable cast iron	<800	170	0,028	0,034	0,036	0,023	0,029	0,031	0,03	0,036	0,038	0,02	0,026	0,028
HINWEIS Die in Türkis markierten Werte sind Nebenanwendungen!															
Die Werte in der Tabelle sind die kürzeste und die längste Freistichlänge (L3) jeder Abmessung; bitte berechnen Sie fz, ap und ae in Abhängigkeit von den angegebenen Werten.  ae/ap(max)=0,5x Eckenradius!															

LEGENDE

























ANWENDUNGEN

 Abzeilen	 Besäumen	 Entgraten	 Gravieren
 Viertelkreisfräsen	 Vollnut	 Vorwärts-Rückwärtsentgraten	





KÜHLUNGEN

 Luftgekühlt	 Trocken	 Öl	 Kühlschmierstoff (KSS)
 Minimalmengenschmierung (MMS)			

EIGENSCHAFTEN

 0,5xD	 1xD	 1,5xD	 2xD
 2,5xD	 3xD	 3,5xD	 4xD
 5xD	 Zentrumschneidend	 Nicht Zentrumschneidend	 Ohne Weldon
 Mit Weldon	 Kühlkanalsystem	 Dynamische Drallsteigung	 Spanbrecher
 Ungleiche Zahnteilung	 Wellenschliff	 Zustellung helikal	 Zustellrichtungen x,y
 Zustellrichtungen x, y, z	 Zustellrichtungen x, y, (z)	 Eckenradius	 Eckfase
 Scharfkantig			

STRATEGIE

 Extended Trochoidal Cutting	 High Performance Cutting	 High Speed Cutting	 Multi Task Cutting
 Universal Machining			



EIGENSCHAFTEN

 Schneidendurchmesser	 Kleiner Schneidendurchmesser	 Großer Schneidendurchmesser	 Freistichdurchmesser
 Schneidenlänge	 Gesamtfasenlänge	 Freistichlänge	 Gesamtlänge
 Schaftdurchmesser	 Schneidenanzahl	 Eckradius	 Eckfase
 Programmerradius	 Maximale Schnitttiefe	 Spiralwinkel	 Winkel Alpha

ANWENDUNGSTABELLE

Bei den angegebenen Werten der Anwendungstabelle handelt es sich lediglich um Richtwerte. Diese sind stark abhängig von der individuellen Anwendungssituation.

ABBILDUNGEN

Alle abgebildeten technischen Zeichnungen und Fotografien sind beispielhaft. Abweichungen zum Originalprodukt bei Farbe und Abmessungen sind möglich.

H 1.1-1.4 HARDENED STEEL | 46-70 HRC

Materialnummer	Germany DIN	Europe EN	France AFNOR	Great Britain BS	Italy UNI	Sweden SIS	Spain UNE	Japan JIS	USA AISI
1.2311	40CrMnMo7			BP 20	35 CrMo 8 KU				P 20
1.2312	40CrMnMoS86		40 CMD 8						
1.2316	X36CrMo17	X 36 CrMo 17	X38CrMo 16 1		X 38 CrMo 16 1 KU		X 38 CrMo 16		D-4
1.2365	X32CrMoV33	X 32CrMoV 12 28	32 DCV 28	BH 10	30 CrMoV 12 27 KU		F.5313	SKD 7	H 10
1.2567	X30WCrV53	X 30 WCrV 5 3	Z 32 WCV 5		X 30 WCrV 5 3 KU			SKD 4	
1.2581	X30WCrV93	X 30 WCrV 9 3	Z 30 WCV 9	BH 21	X 30 WCrV 9 3 KU		X 30 WCrV 9	SKD 5	H 21
1.2738	40CrMnNiMo864		40 CMND 8				F.5303		
1.2885	X32CrMoCoV333		30 DCKV 28						
1.4028	X30Cr13	X 30 Cr 13	Z 30 Cr 13	420 S 45	X 30 Cr 13	2304	X 30 Cr 13	SUS 420 J2	420
1.4031	X40Cr13	X 40 Cr 13	Z 40 C 14		X 40 Cr 14	2304	X 40 Cr 13	SUS 420	420
1.4034	X45Cr13	X 45 Cr 13	Z 40 C 14	420 S 45	X 40 Cr 14		X 46 Cr 13		420
1.4112	X90CrMoV18	X 90 CrMoV 18	Z 3 CT 1 2	409 S 1 9	X 6 Cr Ti 1 2			SUS 440 B	440 B
1.5122	37 MnSi 4		38 MS 5						
1.6358	X2NiCoMoTi 1895								
1.6582	34CrNiMo6		35 NCD 6	817 M 40	35 NiCrMo 6 (KW)	2541	F.1270	SNCM 447	4340
1.7003	38 Cr 2		38 C 2	120 M 36	38 Cr 2		F.1200		
1.7006	46 Cr 2		45 C 2		4 5Cr 2				5045
1.7030	28 Cr 4			530 A 30					5130
1.7176	55 Cr 3		55 C 3	525 A 58	55 Cr 3	2253	F.1431	SUP 9	5155
1.0961	60SiCr7	60 SiCr 8	60 SC 7	250 A 61	60 SiCr 8		60 SiCr 8	SUP 7	9262
1.1248	Ck 75		XC 75	060 A 78		1774			1078
1.1273	90Mn4			060 A 96				SUP 4	1090
1.2083	X42Cr13	X 42 Cr 13	Z 40 C 14		X 41 Cr 13 KU	2314		SUS 420 J2	420
1.2323	48CrMoV67		45 CDV 6						
1.2343	X38CrMoVH1	X 38 CrMoV 5 1	Z 38 CDV 5	BH 11	X 37 CrMoV 5 1 KU		X 37 CrMoV 5	SKD 6	H 11
1.2367	X38CrMoV53		Z 38 CDV 5 3						
1.2510	100 MnCrW 4		90 MWCV 5	B0 1	95 MnWCr 5 KU	2140	F.5220	SKS 3	0 1
1.2542	45WCrV7	45 WCrV 8		BS 1	45 WCrV 8 KU	2710	45 WCrSi 8		S1
1.2550	60 WCrV 7		55 WC 20		55 WCrV 8 KU				
1.2606	X37CrMoW51		Z 35 CWDV 5	BH 12	X 35 CrMoW 05 KU		F.537	SKD 62	H 12
1.2711	54 NiCrMoV		55 NCDV 6						
1.2713	55 NiCrMoV 6		55 NCDV 7				F.520.S	SKT 4	L 6
1.2764	X19NiCrMo4								
1.2767	X45NiCrMo4	40 NiCrMo 4	Y 35 NCD 16		42 NiCrMo 15 7 KU				A 9
1.4109	X65CrMo14	X 70 CrMo 15	Z 70 CD 14					SUS 440 A	440 A
1.1157	40Mn4		35 M 5	150 M 36					1039
1.1231	Ck 67		XC 68	060 A 67	C 70	1770			1070
1.1274	Ck 101		XC 100	060 A 96		1870		SUP 4	1095
1.2080	X210Cr12		Z 200 C 12		X 210 Cr 13 KU			SKD 1	D 3
1.2101	62SiMnCr4								
1.2162	21MnCr5	21 MnCr 5	20 NC 5					SCR 420 H	
1.2201	X165CrV12								
1.2210	115CrV3	107 CrV 3 KU	100 C 3		107 CrV 3 KU		F.520.L		L2
1.2341	X6CrMo4								
1.2379	X155CrVMo121	X 153 CrMoV 12	Z 160 CDV 12	BD 2	X 155 CrVMo 12 1 KU	2310		SKD 11	D 2
1.2419	105WCr6	105 WCr 5	105 WC 13		107 WCr 5 KU	2140	105 WCr 5	SKS 31	
1.2601	X165CrMoV12	X 165 CrMoV 12			X 165 CrMoW 12 KU	2310	X 160 CrMoV 12		
1.2721	50NiCr13								
1.2735	15NiCr14		10 NC 12					SNC 22	
1.2833	100V1		Y1 105 V	BW 2	102 V 2 KU			SKS 43	W 210
1.2842	90MnCrV8	90 MnV 8	90 MV 8	BO 2	90 MnVCr 8 KU				0 2
1.3505	100Cr6		100 C 6	534 A 99	100 Cr 6	2258	F.1310	SUJ 2	52100
1.4125	X105CrMo17		Z 100 CD 17		X 105 CrMo 17			SUS 440 C	440 C
1.8161	58CrV4								
1.1520	C70W1								
1.2363	X100CrMoV51	X 100 CrMoV 5 1	Z 100 CDV 5	BA 2	X 100 CrMoV 5 1 KU	2260	X 100 CrMoV 5	SKD 12	A 2
1.2436	X210CrW12	X 210 CrW 12	Z 210 CW1 2		X 215 CrW 12 1 KU	2312	X 210 CrW 12	SKD 2	
1.2880	X165CrCoMo12								
1.3202	S12145	HS12-1-5-5		BT 15	HS 12-1-5-5		12-1-5-5		T 15
1.3207	S104310	HS10-4-3-10	Z130WKCDV10-10-04-04	BT 42	HS 10-4-3-10		10-4-3-10	SKH 57	M 44
1.3243	S6525	HS6-5-2-5	KCV 06-05-05-04-02		HS 6-5-2-5	2723	6-5-2-5	SKH 55	M 35
1.3246	S7425	HS1-8-1	Z110 WKCDV 07-05-04	T 11341	HS 7-4-2-5		7-4-2-5		M 41
1.3247	S21018	HS2-9-1-8	Z110 DKCWV 09-08-04	BM 42	HS 2-9-1-8		2-10-1-8		M 42
1.3249	S2928			BM 34			2-9-2-8		

Materialnummer	Germany DIN	Europe EN	France AFNOR	Great Britain BS	Italy UNI	Sweden SIS	Spain UNE	Japan JIS	USA AISI
1.3257	S181215								
1.3333	S332	HS 3-3-2			HS 3-3-2				
1.3343	S652	HS6-5-3	Z85 WDCV 06-05-04-02	BM 2	HS 6-5-2	2722	6-5-2	SKH 51	M2
1.3344	S653		Z120 WDCV 06-05-04-03				6-5-3	SKH 52	M 3 Cl.2
1.3346	S291	HS1-8-1	Z85 DCWV 08-04-02-01	BM 1	HS 1-8-1				M1
1.3348	S292	HS2-9-2	Z100 DCWV 09-04-02-02		HS 2-9-2	2782	2-9-2		M 7
1.3355	S1801	HS18-0-1	Z80 WCV 18-04-01	BT 1	HS 18-0-1		18-0-1	SKH 2	T 1
1.1654	C 110 W								

Technische Formeln

Schnittgeschwindigkeit berechnen (m/min)

$$V_c = \frac{D \cdot \pi \cdot n}{1000}$$

Drehzahl berechnen (U/min)

$$n = \frac{V_c \cdot 1000}{D \cdot \pi}$$

Vorschubgeschwindigkeit berechnen (mm/min)

$$V_f = n \cdot z \cdot f_z$$

Zahnvorschub berechnen (mm/Z)

$$f_z = \frac{V_f}{n \cdot z}$$

Zeitspanvolumen berechnen (cm³/min)

$$Q = \frac{a_p \cdot a_e \cdot V_f}{1000}$$

Mittlere Spandicke berechnen (mm)

$$h_m = f_z \cdot \frac{\sqrt{a_e}}{D}$$

Begriffserläuterung

V_c Schnittgeschwindigkeit in m/min

n Drehzahl in U/min

V_f Vorschubgeschwindigkeit in mm/min

F_z Zahnvorschub in mm/Zahn

z Anzahl der Zähne (Schneiden)

a_p Zustelltiefe in mm

a_e Eingriffsbreite in mm

h_m Mittlere Spandicke in mm

Q Zeitspanvolumen in cm³/min

D Durchmesser Werkzeug in mm